

Resson

Technologies

The People that Always Committed to Quality, Technology & Innovation

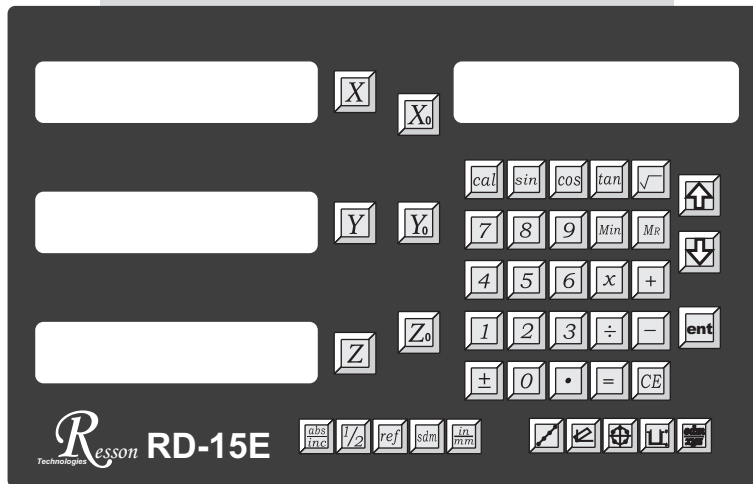

RD-15E DRO Counter Operation Manual (EDM)

Resson Technologies Co., Ltd.

Note before using this display !

● Use the defined voltage

The rated power voltage supplied to this display should be 100V~230V, select correct voltage supply and try best supplying the power from lighting power line!

Since the power circuit would become unstable under frequent power on/off and cause instant strong interference or even power shutdown; take special note on it!

● Ground the display!

To guaranty user safety and stable & reliable system work, we strongly request user connecting the attached ground line (3-m yellow-green cable packed in the packaged box to the FC terminal at back of display to make good grounding connection!

● Insert each axis optic rule into correct position before turning on display; if doing the turn inversely, it might burn out the electronic devices in the optic ruler!

● Do not operate this display in elevated ambient temperature or under high humidity!

● Do not operate this display in strong electric field, magnetic field or noisy environment, or by electric machine that would be the main reason making system act in error!

● Use dry, soft cloth to wipe cleaning display surface!

● For stain hard to remove, use soft cloth wet by neutral detergent to clean it up!

● Do not use gasoline, diesel fuel, kerosene or alcohol to wipe cleaning the display surface!

● Do not use compressing air gun to blow display and optic scale assembly since it would blow oil, moisture, dust or chips into them from seam and cause system unstable and damage!

Elaborate maintenance, correct operation;

Extend operation lifetime and stabilize work performed

**Thanks for buying our product! To use it correctly,
read this Operation Manual carefully and in details.**

RD-15E Specification :

Number of axes : 3

Resolution : 0.05/0.02/0.01/0.005/0.002/0.001/0.0005/0.0002/0.0001mm

Display function : 8-digit LED

Response speed : 60m (198.6feet)/min

Quantizing error : ± 1 count

Power source : AC100V~230V / 50~60Hz / 20VA

Temperature fange : Service:0~40°C / Storage:-20~70°C

Linear Encoter (Scales) Electrical connector :

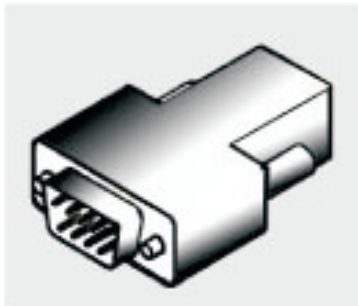

D-sub 9 pins connector

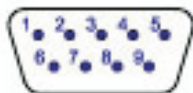

TTL

PIN	SIGNALS	COLOR
1	N/C	
2	0V	White
3	N/C	
4	Inner shield	
5	N/C	
6	A	Green
7	5V	Brown
8	B	Blue
9	R	Gray

N/C : No Connection

RS422

PIN	SIGNALS	COLOR
1	A-	Yellow
2	0V	White
3	B-	Red
4	Inner shield	
5	R-	Pink
6	A+	Green
7	5V	Brown
8	B+	Blue
9	R+	Gray



DIN 7 pins connector



PIN	SIGNALS	COLOR
1	0V	White
2	N/C	
3	A	Green
4	B	Blue
5	5V	Brown
6	R	Gray
7	Inner shield	

N/C : No Connection

RS232 output port

This display has RS232-C output port facilitating user to print out the measuring result or connect it to a computer; the port's picture is as below.

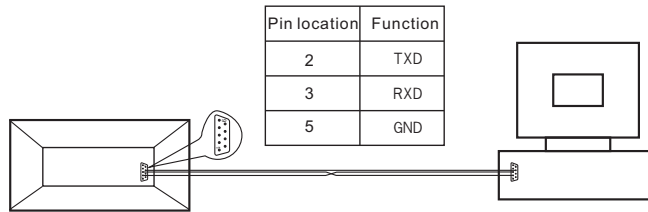



The display's RS232 output port transmission parameters are:

BAUD RATE : 57600/19200/9600/4800/2400/1200bps
 DATA : 8 data bits
 STOP BITS : 1 stop bit

Through the display's RS232 output port, we can output display data to a computer or send the output or reset command to display from the computer; such as asking axis X to reset CX, axis Y to reset CY and axis Z to reset CZ.

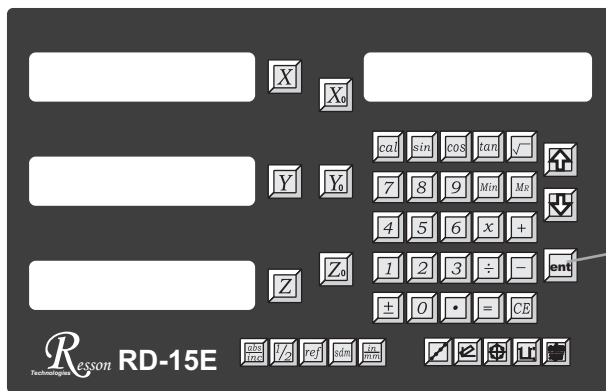
RS232 output function



Press  to output display data; and set the "print" option to "on"; to apply two-way communication, set the "print" option to off.

User may select EPSON LQ-300+RS232 as the working printer; set speed to 19200bps and turn on the print to standby.

The back shell plug seat of DRO.

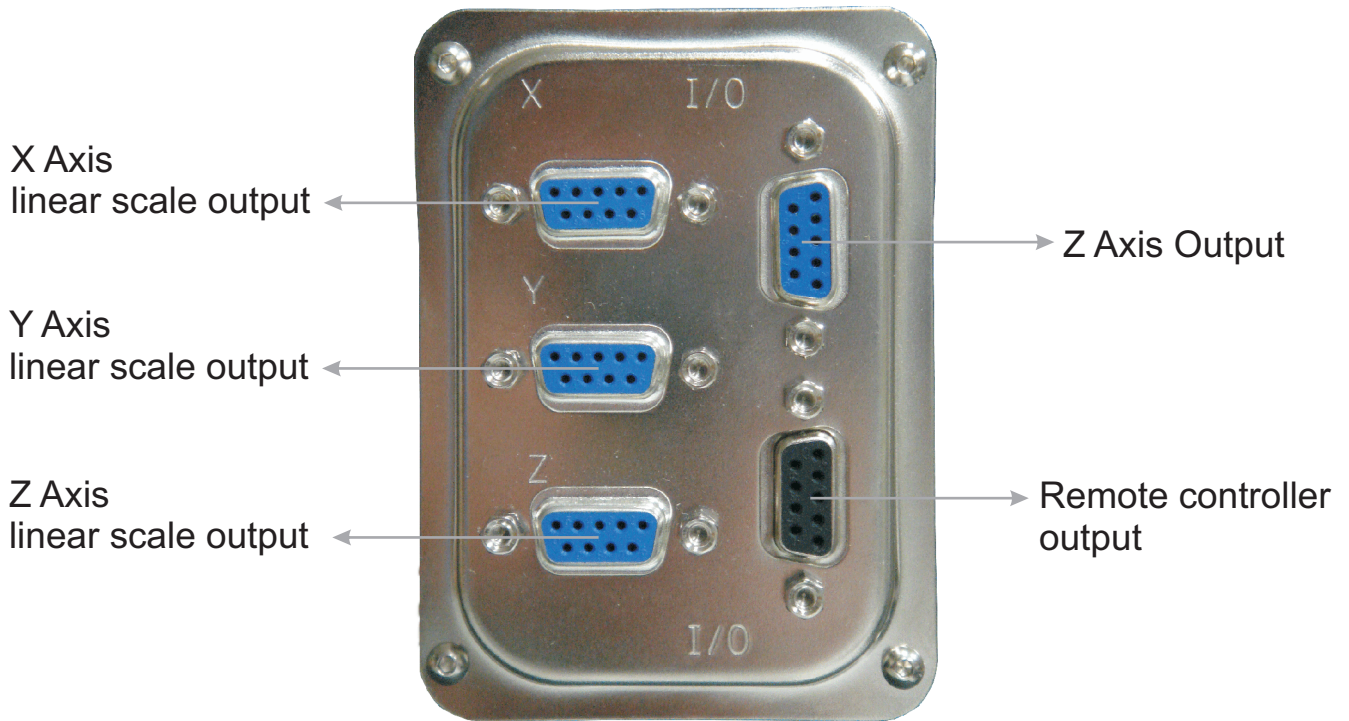

一. Basic Functions	1
二. REF datum memory	5
三. 199 SubDatum Function	9
四. Built-in Calculator	19
五. LHOLE Function	25
六. INCL Function	31
七. PCD Function	37
八. EDM Function	45
九. RD-15E Setup Function	51

Basic Functions

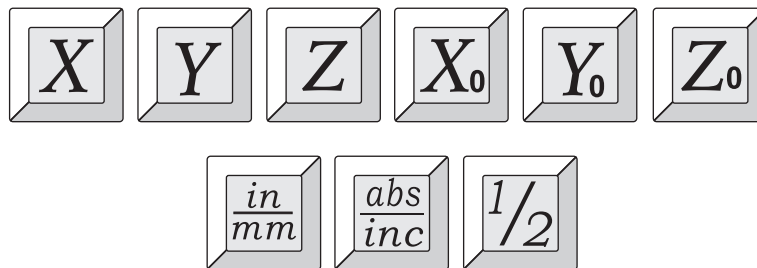
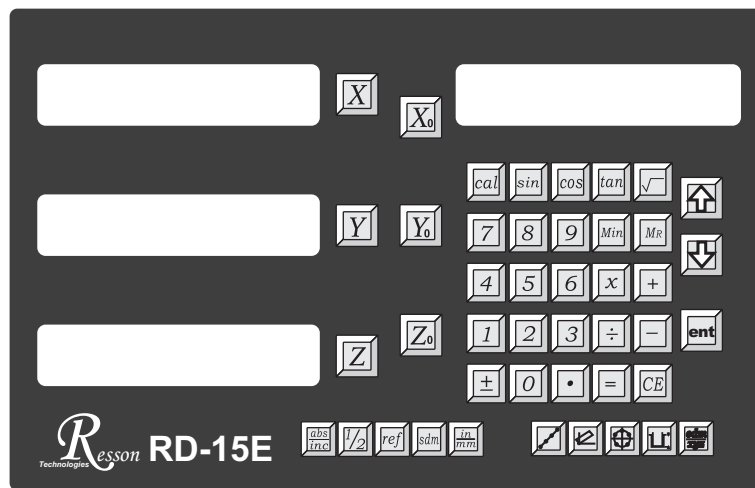

Set Display to Zero

Purpose : Set the current position for that axis to zero

Example : To set the current **X Axis** position to zero

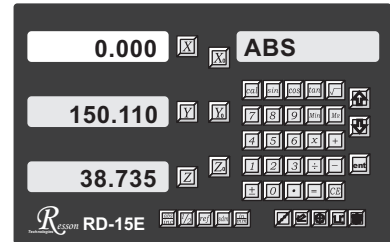
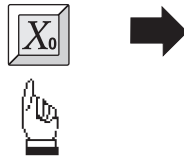
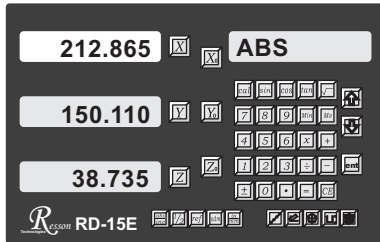

Inch / Metric Display Conversion

Purpose : Switches between inch and metric display

Example 1 : Currently in **inch** display, to switch to **metric** display

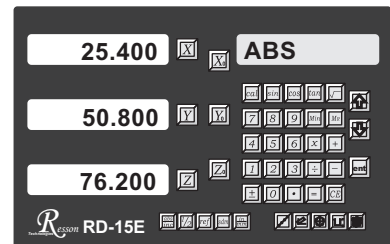
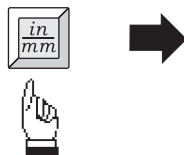
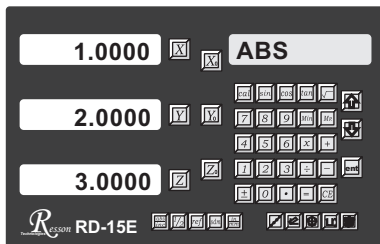

Example 2 : Currently in **metric** display, to switch to **inch** display

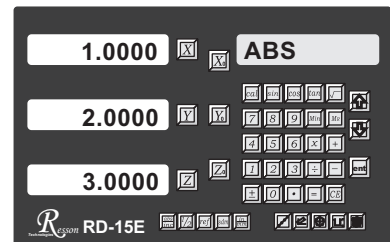
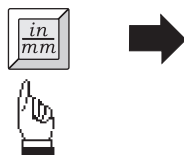
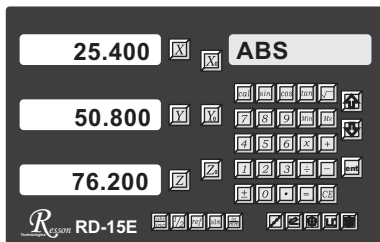

Enter Dimensions

Purpose : Set the current position for that axis to an entered Dimension

Example : To set the current **X Axis** position to 45.800 mm

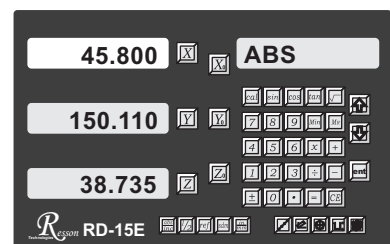
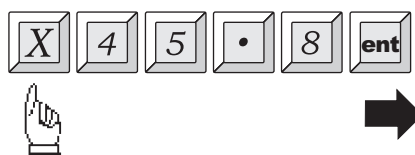
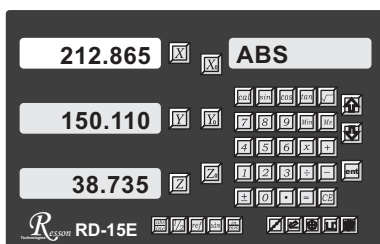

Purpose : RD-15E provides two sets of basic coordinate display, they are **ABS** (absolute) and **INC** (incremental) displays.

During machining operations, the operator can *store the work piece datum (zero position)* in **ABS** coordinate, then switch to **INC** coordinate to continue machining operations.

The operator is then free to zero the axes or preset any dimensions into any axis in **INC** coordinate for relative position machining. The work piece datum (work piece zero position) is still retained in **ABS** coordinate by the **RD-15E**.

Operator can then toggle between **ABS** (absolute) and **INC** (incremental) coordinates without losing the work piece datum (work piece zero position).

Example 1 : Currently in **ABS** display coordinate, to switch to **INC** display coordinate

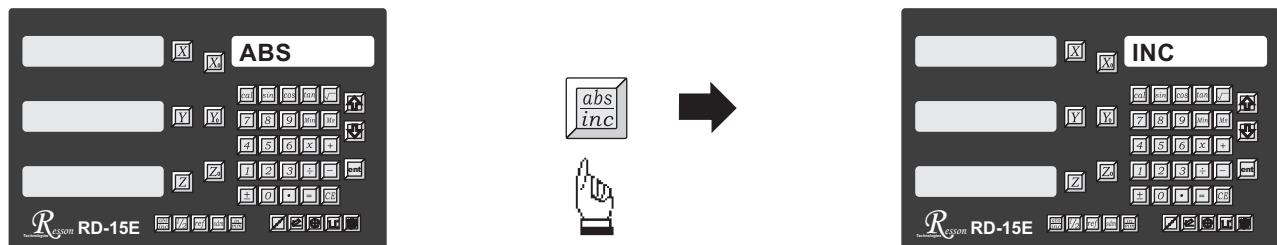

Example 2 : Currently in **INC** display coordinate, to switch to **ABS** display coordinate

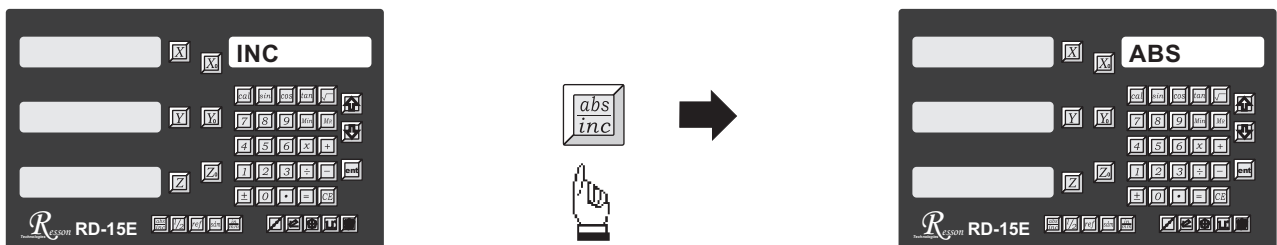

Purpose : RD-15E provides the centre-find function by halving the current display coordinate, so that the zero point of the work piece is located at the centre of the work piece.

Example : To set the X Axis zero point at the centre of the work piece.

Step 1 : Locate the edge finder at one end of the work piece, then zero the X Axis.

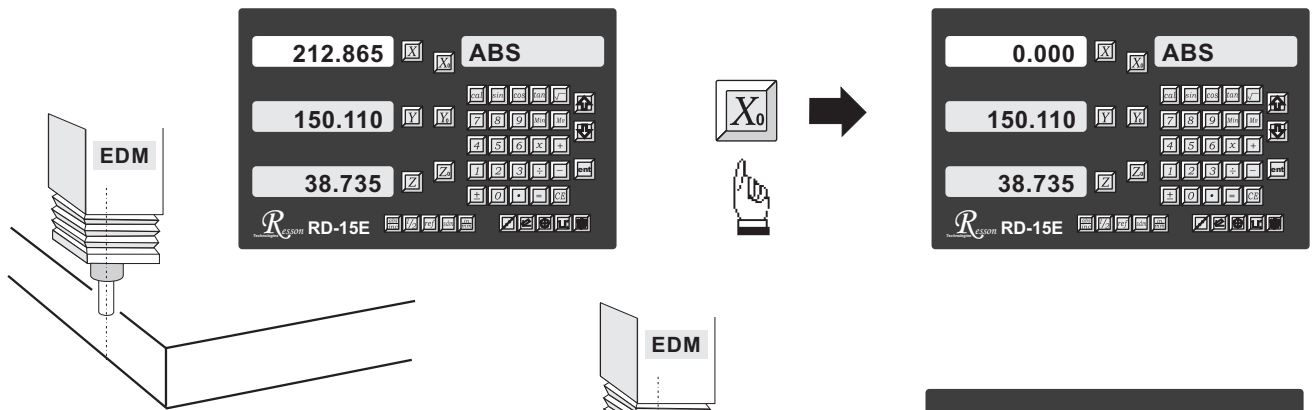

Step 2 : Locate the edge finder at the opposite end of the work piece.

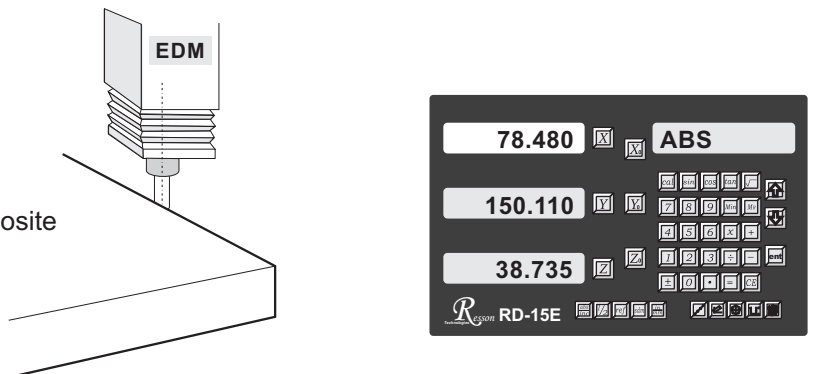

Step 3 : Then half the display coordinate using centre-find function as per follows:

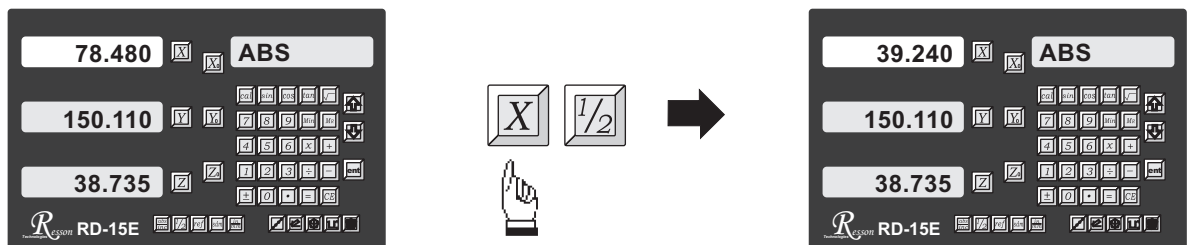

Now the X Axis zero point (0.000) is located at the X centre of the work piece.

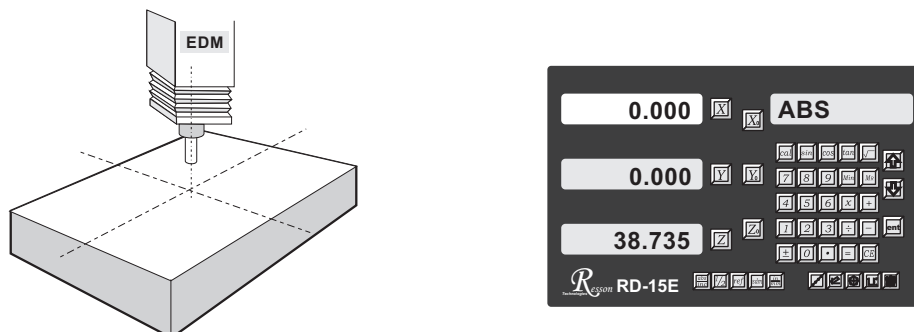

ref datum memory

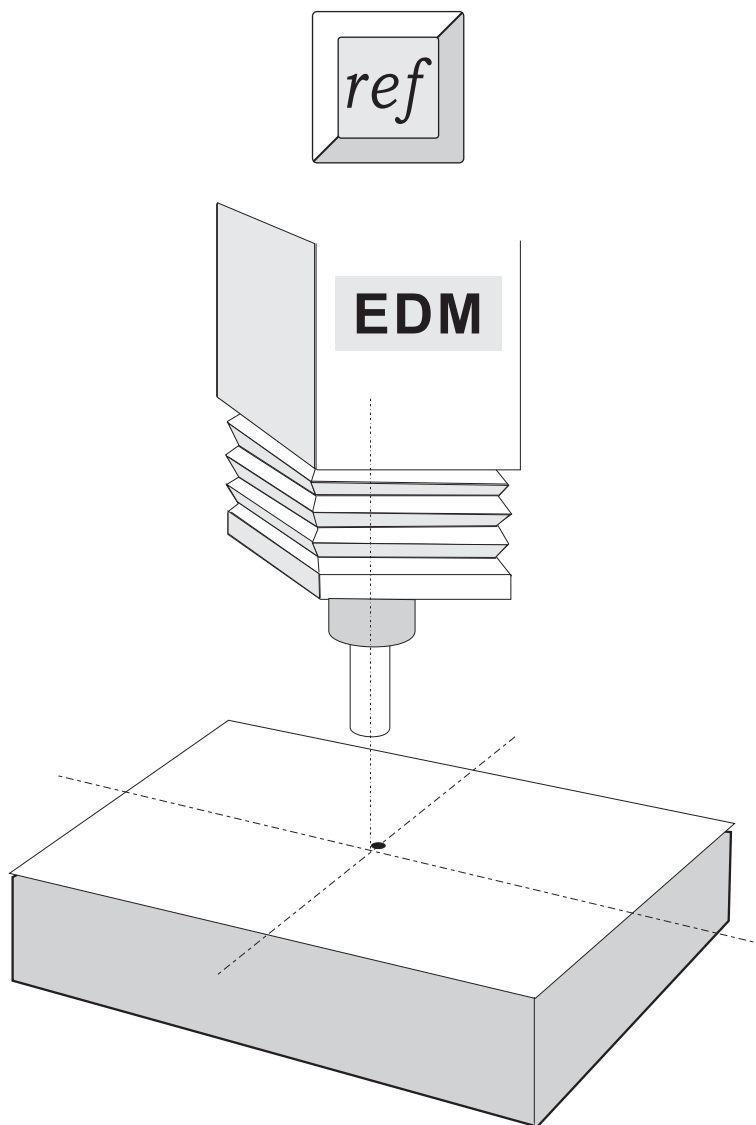

function : During the daily machining process, it is very common that the machining cannot be completed within one working shift, and hence the DRO has to be switched off, or less commonly, a power failure occurs whilst machining which leads to loss of the work piece datum (work piece zero position). The re-establishment of work piece datum using edge finder or other method inevitably introduces machining inaccuracies, because it is not possible to re-establish the work piece datum exactly at the previous position.

To allow the recovery of work piece datum very accurately, with no need to re-establish the work piece datum using an edge finder or other methods, every transducer has a reference point location to provide a datum point memory function.

The working principal of the ref datum memory function is as follows.

- There are a permanent and fixed mark (position) on the transducer, normally called **ref** mark or **ref** point..

Since this **ref** point position is permanent and fixed, it will never change or disappear when the DRO system is switched off. Therefore, we simply need to store the distance between the **ref** point and the work piece datum (zero position) in DRO's memory. Then, in case of the power failure or the RD-15E being switched off, we can recover the work piece datum (zero position) by presetting the display zero position as the stored distance from the **ref** point.

Example : to store the X axis work datum

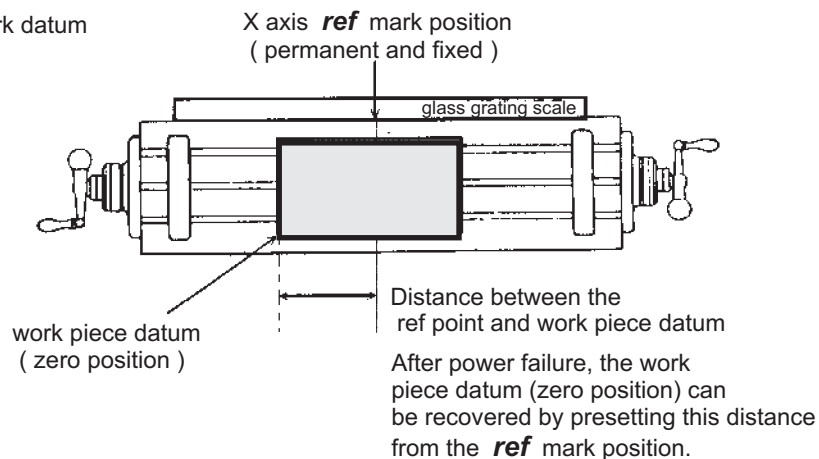

Operation : RD-15E provides one of the most easy-to-use **ref** datum memory function.

There is no need to store the relative distance between the **ref** mark and your work datum zero into the RD-15E, whenever you alter the zero position of **ABS** coordinate, such as by zeroing, centre find, coordinate preset or etc., RD-15E will automatically store the relative distance between **ABS** zero and the **ref** mark location into RD-15E's memory.

In daily operation, operator simply needs to locate the **ref** mark position whenever they switch on the RD-15E to let it know where the **ref** mark position is, then RD-15E will automatically do the work datum storage on its' own . In the case of a power failure or the RD-15E being switched off, the operator can recover the work piece datum easily by using the **RECALL 0** procedure.

Find the scale's *ref* mark position (FIND REF)

function : In ref datum memory function, the **RD-15E** will automatically store the relative distance between the *ref* mark position and the work piece datum (zero position) whenever the operator alter the **ABS** zero position, such as zeroing, centre find, co-ordinate preset or etc...

Therefore, the **RD-15E** needs to store the *ref* mark position prior to any machining operation. So that the loss of the work piece datum (zero position) is avoided during any accidental or unexpected events, such as power failure or etc.. it is recommend that the operator finds the *ref* mark position using the (**FIND REF**) function whenever he switches on the **RD-15E**.

step 1 : To enter the ref function, select the **FIND REF** (find *ref* mark)

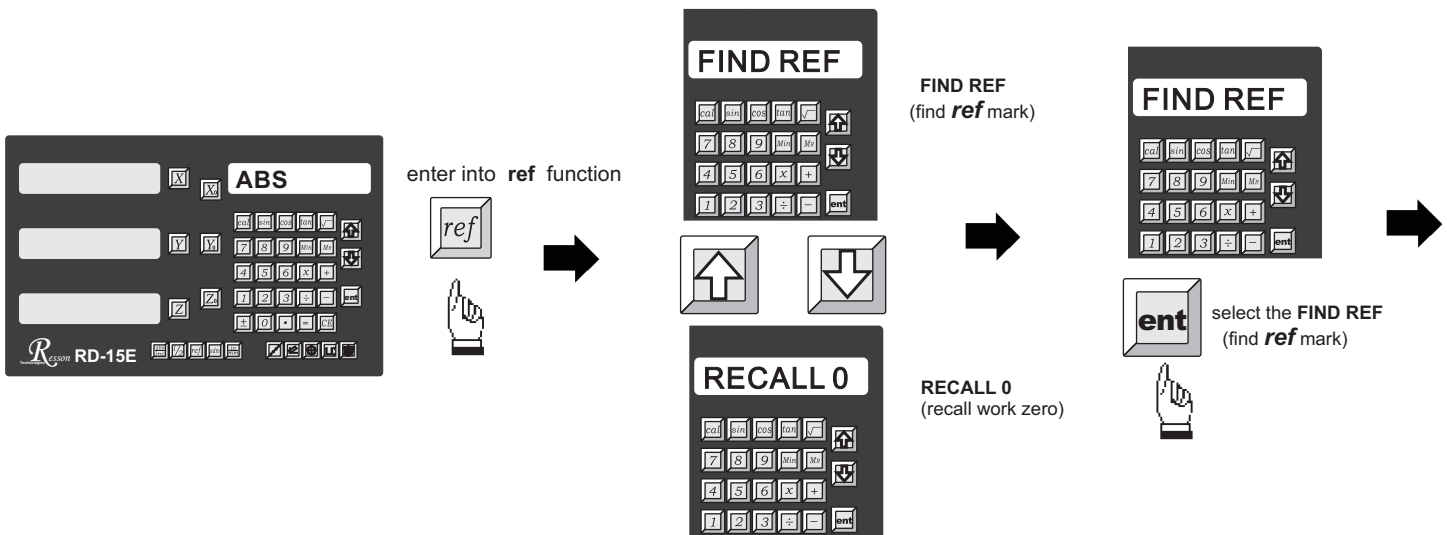

step 2 : select the axis of which *ref* mark needs to be found

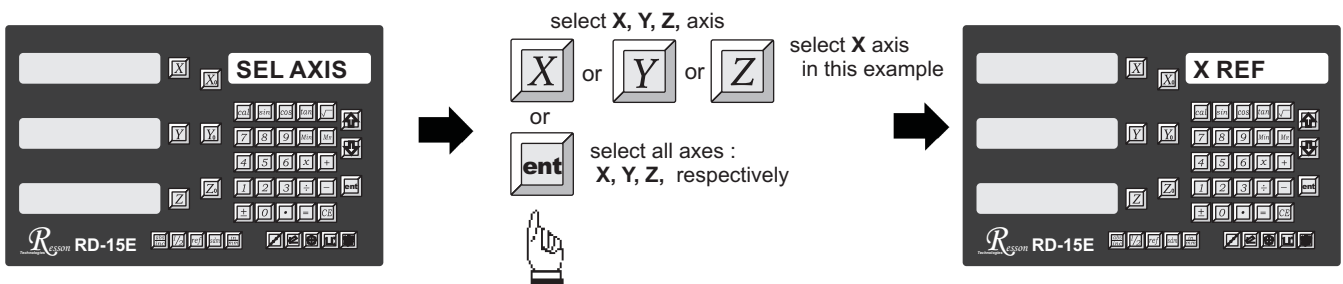

step 3 : move the machine reader head across the length of the transducer until digits display in **RD-15E** start to count.

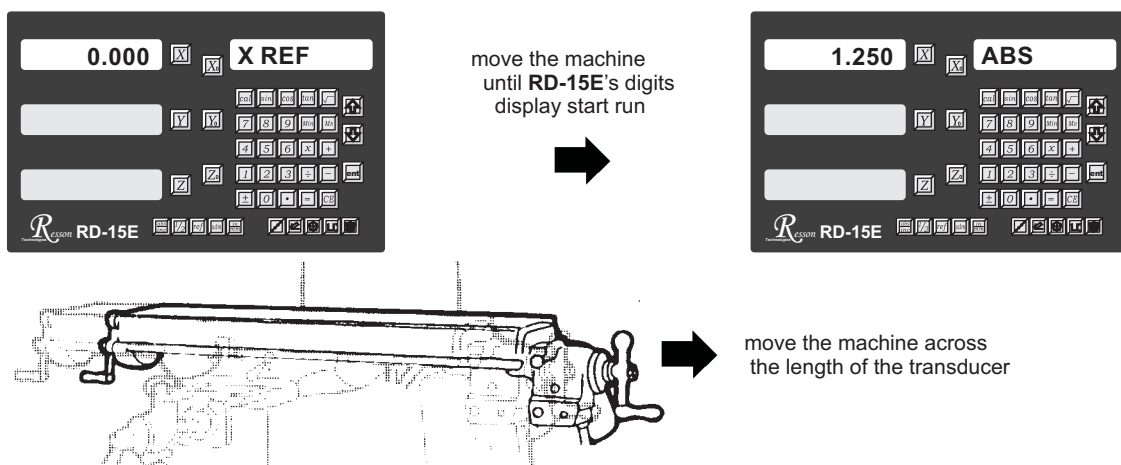

function : If the ref point is lost for any reason, the work piece datum can be recovered by **RECALL 0** function as follows:.

step 1 : enter into the **ref** function, select the **RECALL 0** (recall work piece zero)

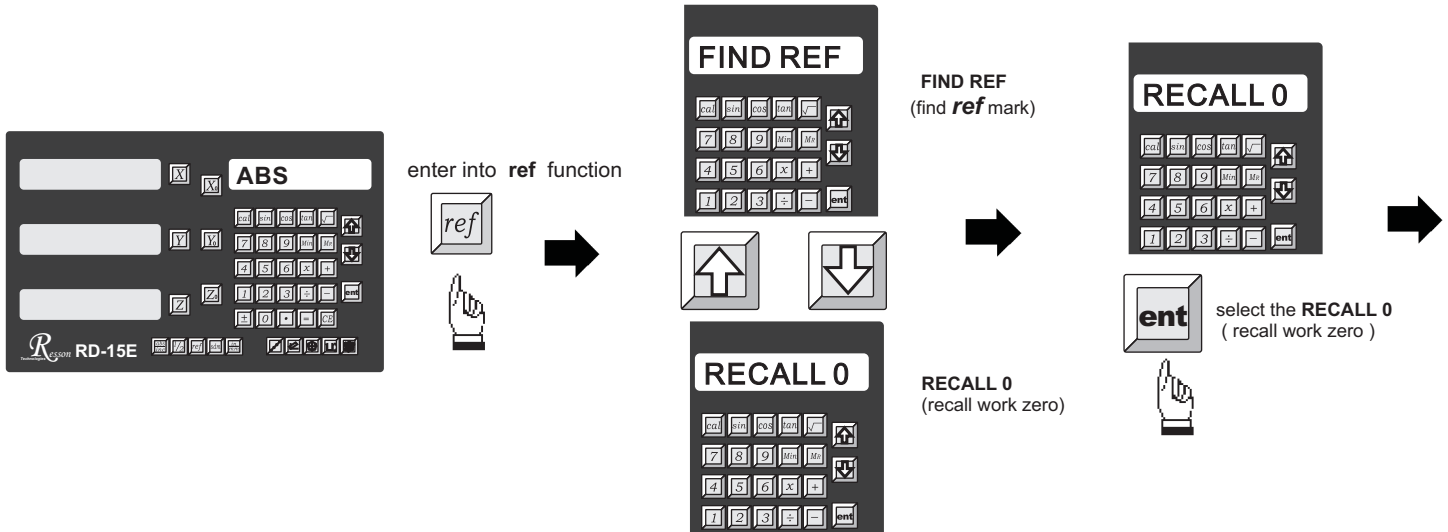

step 2 : select the axis of which work datum (zero position) needed to be recovered

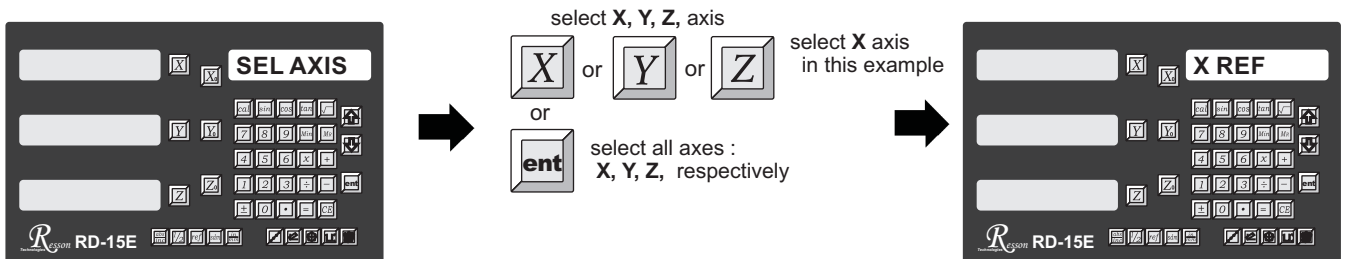

step 3 : move the machine across the length of the transducer until the **RD-15E** display starts to count, then the work piece datum is recovered

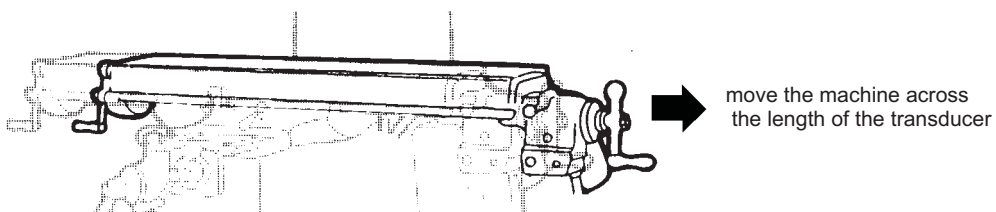

199 SubDatum Function

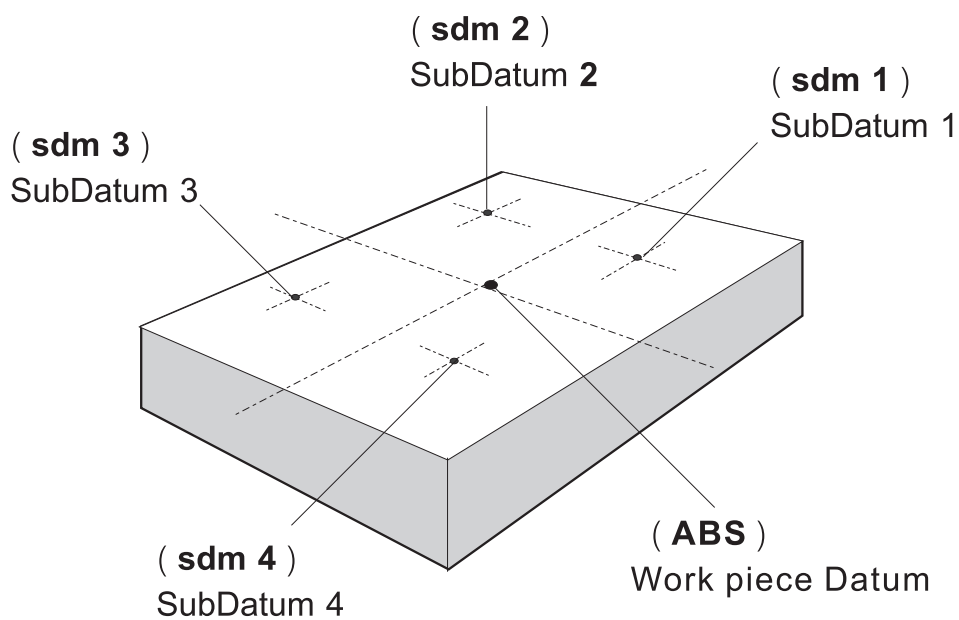

Purpose : Most **DRO** cabinet on the market provide just two set of work co-ordinates - **ABS/INC**. It was found that **ABS/INC** was inadequate and inconvenient to use, and, particularly in the case of complex machining or repetitive work, which needed more than just two sets of working co-ordinates.

ABS / INC operation has the following shortfalls :

- In much machining work, the work-piece machining dimensions are derived from more than two datums, therefore, the operator has to switch between **ABS** and **INC** to set up the machining datums time after time. This process is very time consuming and prone to error.
- In the case of batch machining of repetitive work, the operator has to set up and calculate all the machining positions time after time.

RD-15E provides a **199** subdatum (**sdm**) memory to cope with the shortfalls of **ABS/INC**. **Sdm** function does not just simply provide **199** sets of **INC** co-ordinates, it is specially designed to provide much more convenient features for the operator to cope with repetitive work. The difference between **INC** and **Sdm** is as follows:.

1. **INC** is independent of **ABS** and will not follow any change in **ABS** zero point. All **sdm** co-ordinates are relative to the **ABS** coordinates, so, all **SDM** positions will move together when the **ABS** zero position changes.
2. All **Sdm** relative distance data to **ABS** can be entered directly into **RD-15E** memory using the keypad. No need for any additional calculations.

Sdm application in a work piece that has more than one datum.

Operator can store all the work subdatums in RD-15E's memory as per follows.

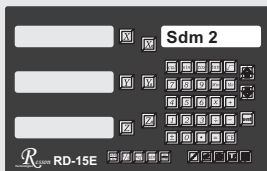
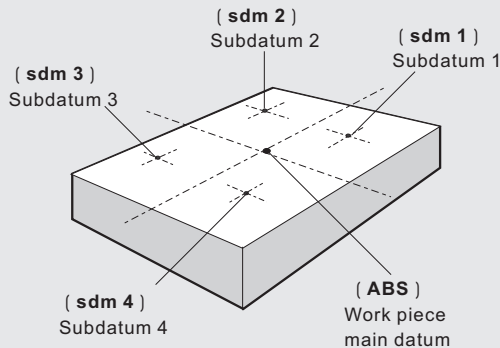

Operator then can switch between the subdatums directly by pressing key
No need to refer back to ABS coordinate and set up the subdatums from their relative distance from ABS point

Sdm application on the repetitive batch machining of parts

Because all sdm subdatums (0.000) are relative to ABS zero, so, for any repetitive work, the operator just needs to set up the first work piece zero at ABS and store the machining position in subdatum zero.

For anymore repetitive parts, just set up the 2nd, 3rd.. work piece zero at ABS, then all the machining positions will reappear

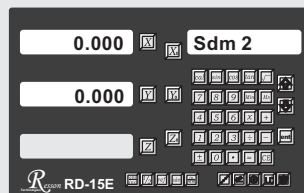
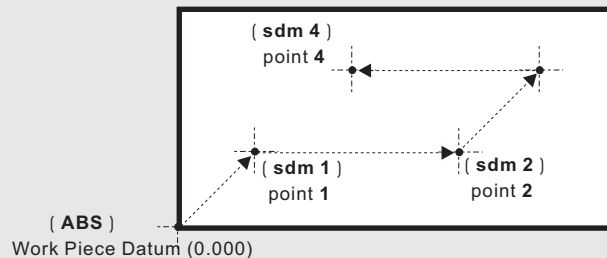

Press Up/Down key to go to machining points
move the machine to display = 0.000, then machining location reached

199 SubDatum function

Application example:

To set up four subdatum zero (**SdM 1** to **SdM 4**) the following two methods can be used

- Either 1. Move machine to required subdatum position, then zero **SdM** display coordinates
- Or 2. Directly key in the **sdm** zero position co-ordinates (co-ordinate relative to **ABS** zero)

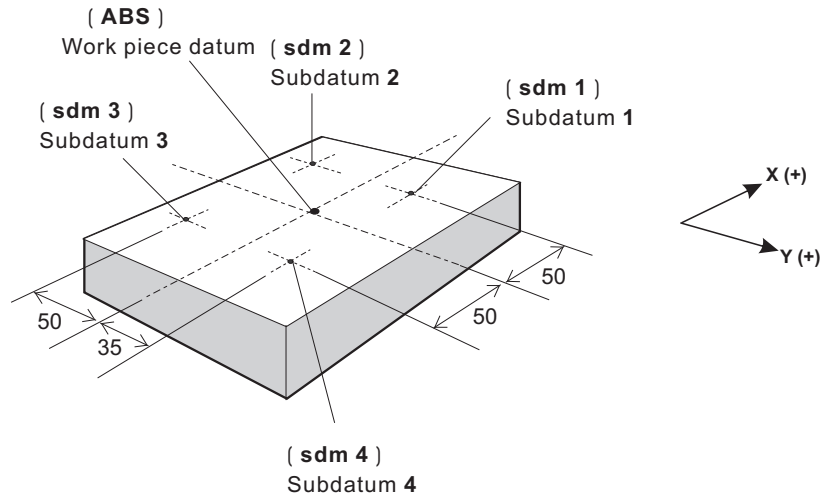

Method 1 : Move machine to required subdatum position, then zero SdM display coordinate

Set up the work piece datum in **ABS** co-ordinate, move the machine to the required subdatum position, then zero **SdM** display co-ordinate.

Step 1 : Set up the work piece datum in **ABS** co-ordinate

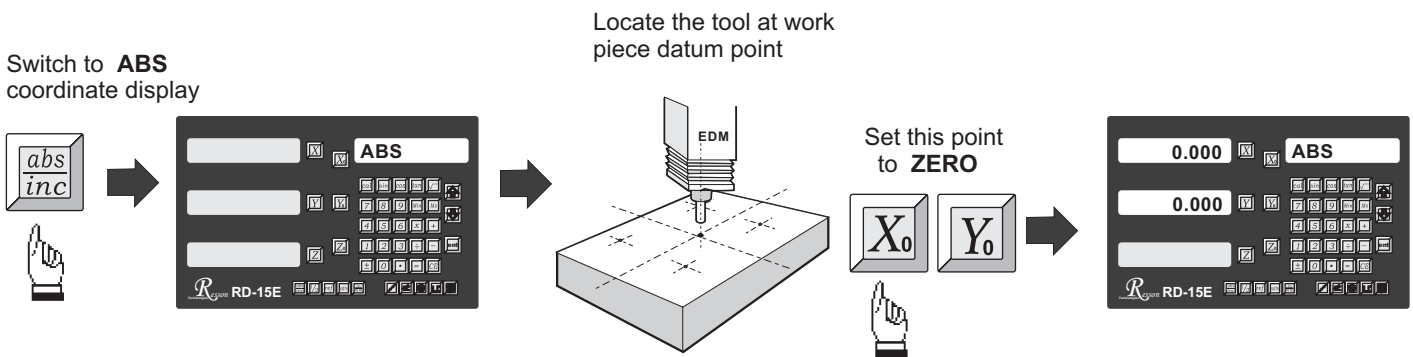

Step 2 : Set up the subdatum point 1 (**sdm1**)

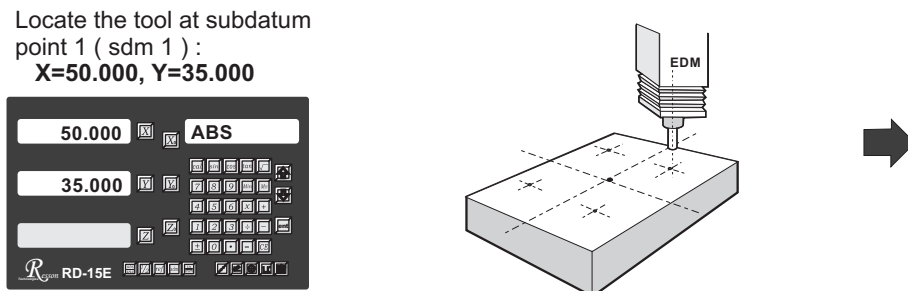

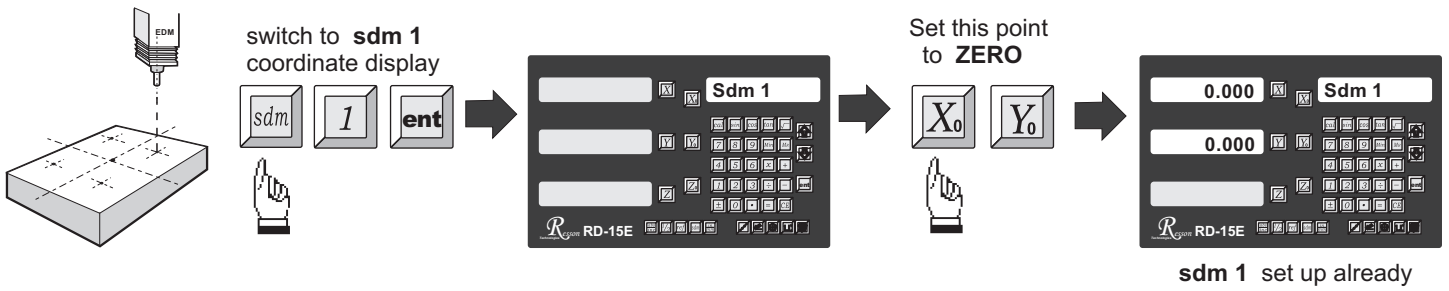

Step 3 : Set up the subdatum point 2 (sdm 2)

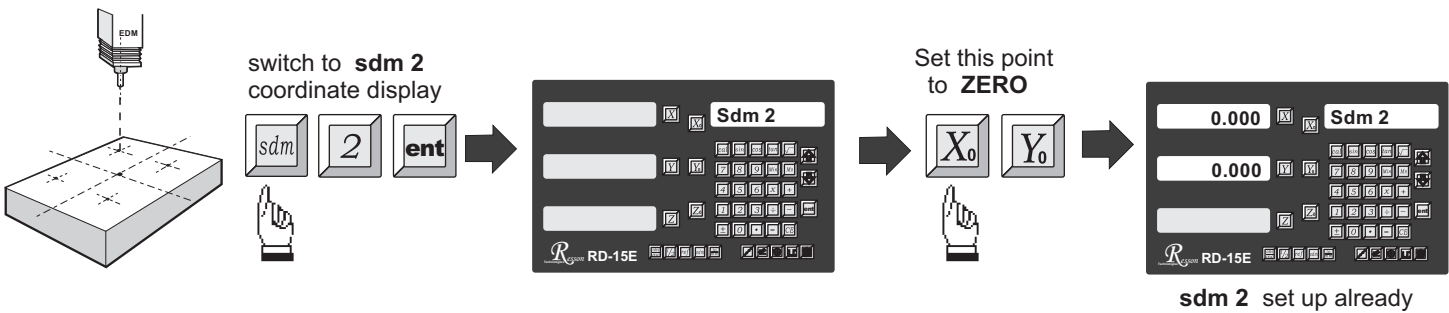
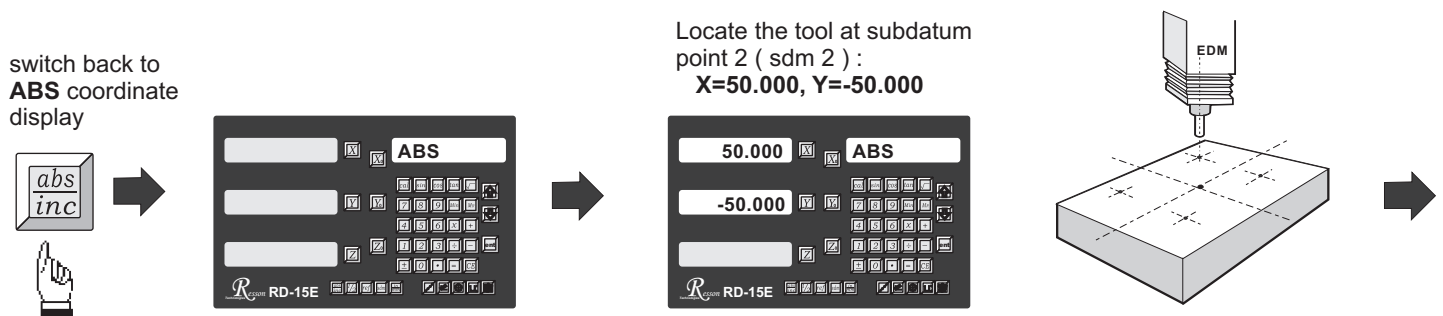

Step 4 : Set up the subdatum point 3 (sdm 3)

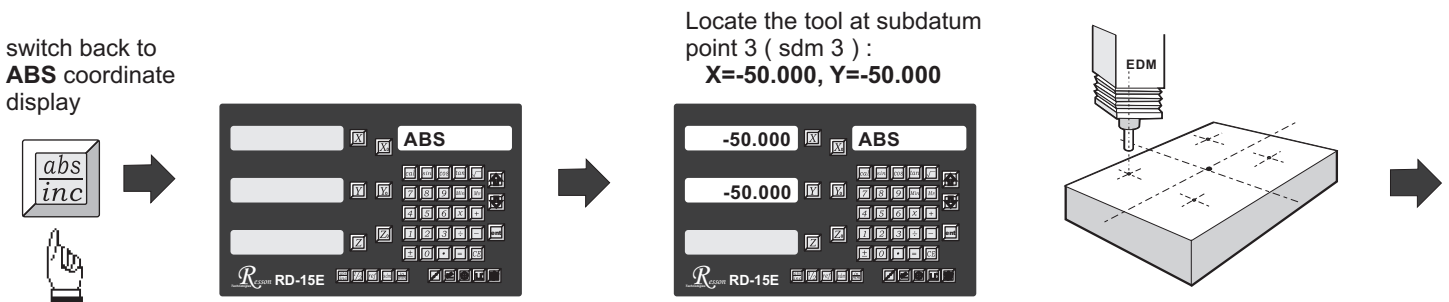

199 SubDatum function

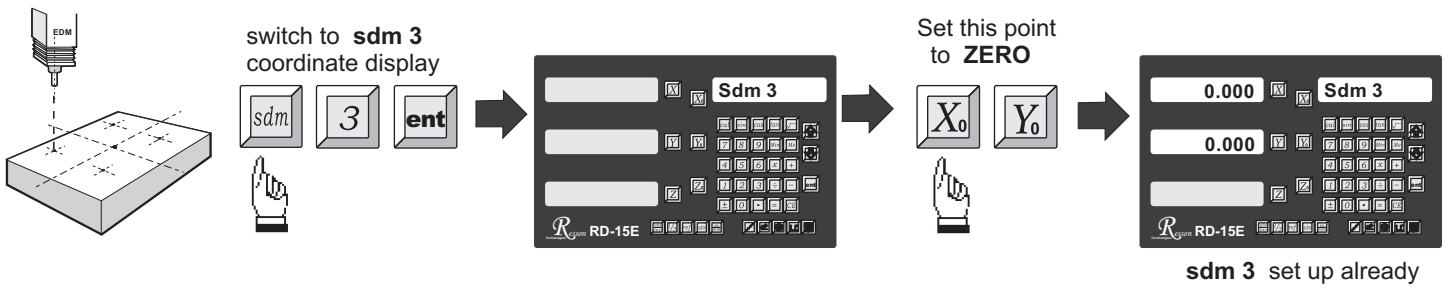

Step 5 : Set up the subdatum point 4 (sdm 4)

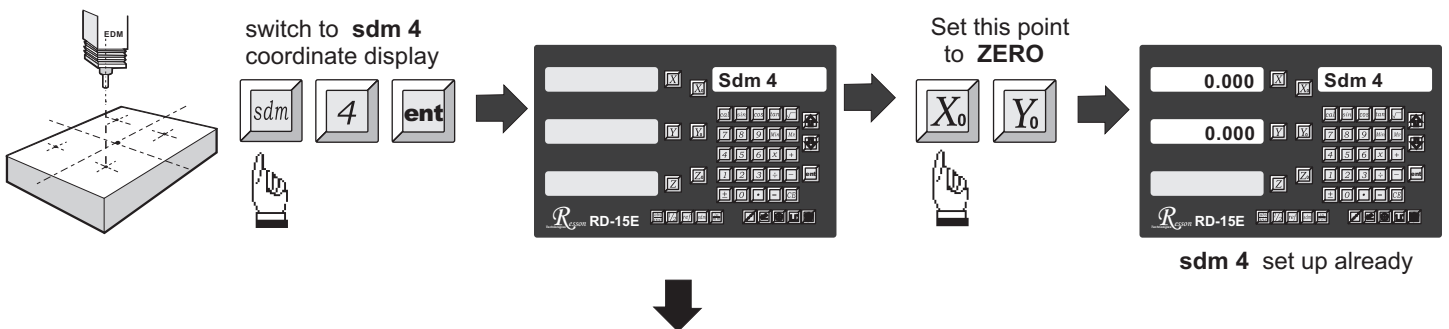
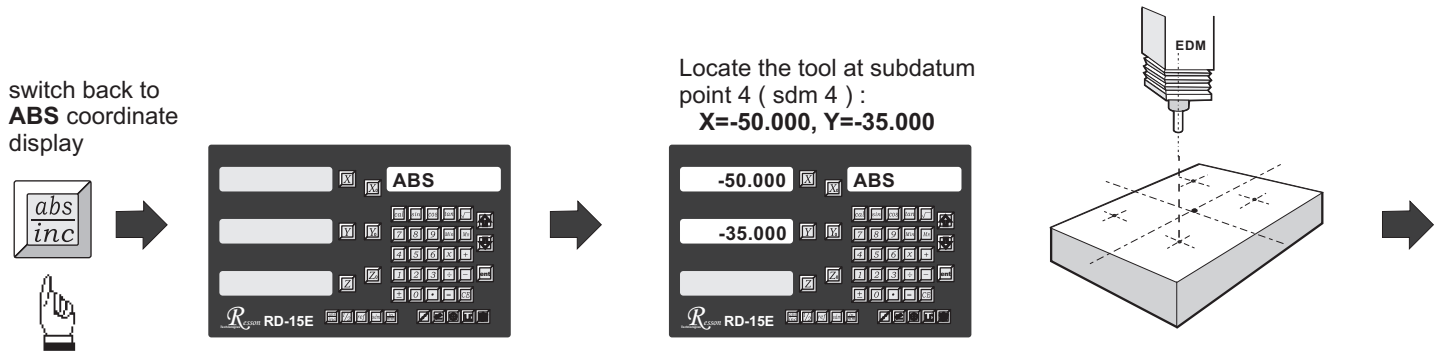

All the four subdatum points have already been set up

Operator can or to directly switch to the required subdatum (sdm) coordinate

Example :

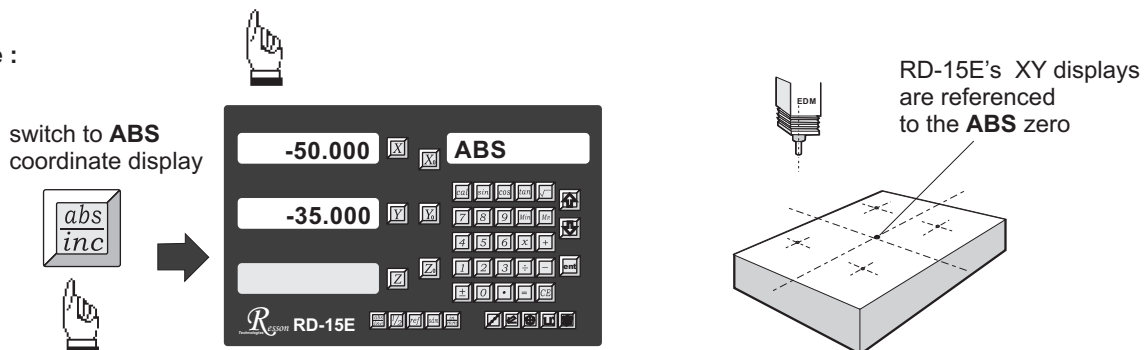

switch to next (**up**)
sdm coordinate display

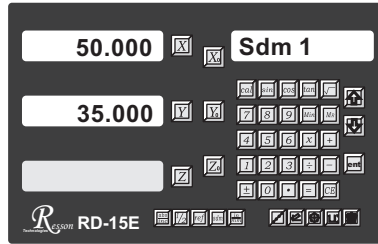
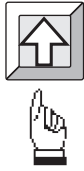

RD-15E's XY displays
are referenced
to the **sdm 1** zero

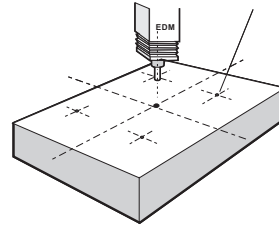

switch to next (**up**)
sdm coordinate display

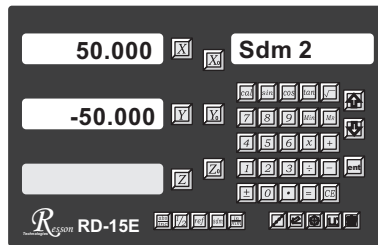

RD-15E's XY displays
are referenced
to the **sdm 2** zero

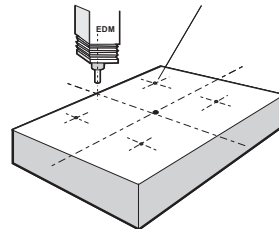

switch to previous (**down**)
sdm coordinate display

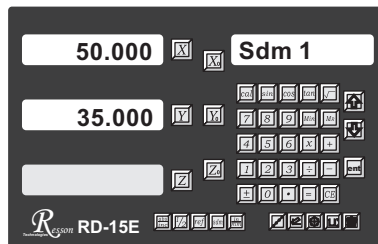

RD-15E's XY displays
are referenced
to the **sdm 1** zero

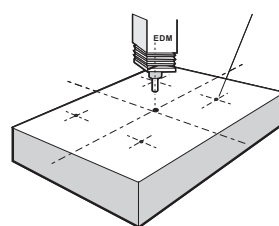

199 SubDatum function

In a case where many subdatum (sdm) points need to be set up, the operator will find that the method of **direct keying in the of Sdm zero position co-ordinates (co-ordinate relative to ABS zero)** is much quicker and less prone to error.

Mthoed 2 : Direct keying in the of Sdm zero position co-ordinate (co-ordinate relative to ABS zero)

Set up the work piece datum (ZERO) at ABS co-ordinate, then move the tool located at the work piece datum (ABS zero point) and directly key in all subdatum point co-ordinates (the relative position to ABS zero) using the keypad.

Step 1 : Set up the work piece datum in ABS coordinate

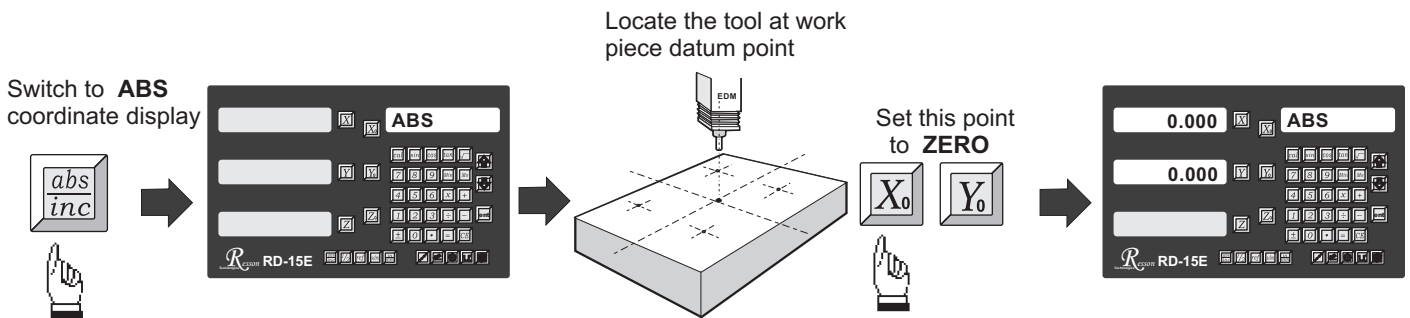

Step 2 : Set up the subdatum point 1 (sdm 1)

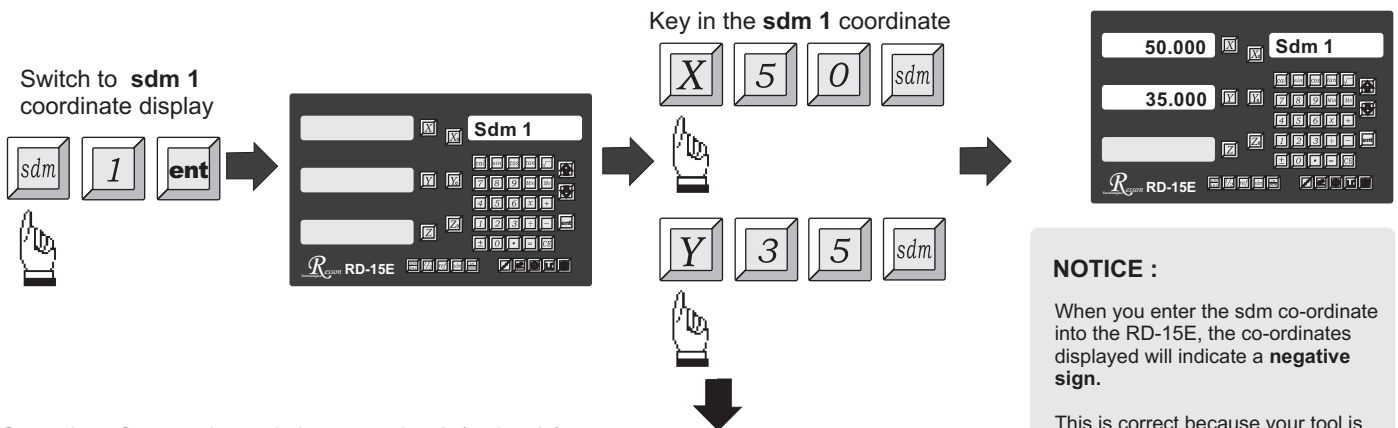

Step 3 : Set up the subdatum point 2 (sdm 2)

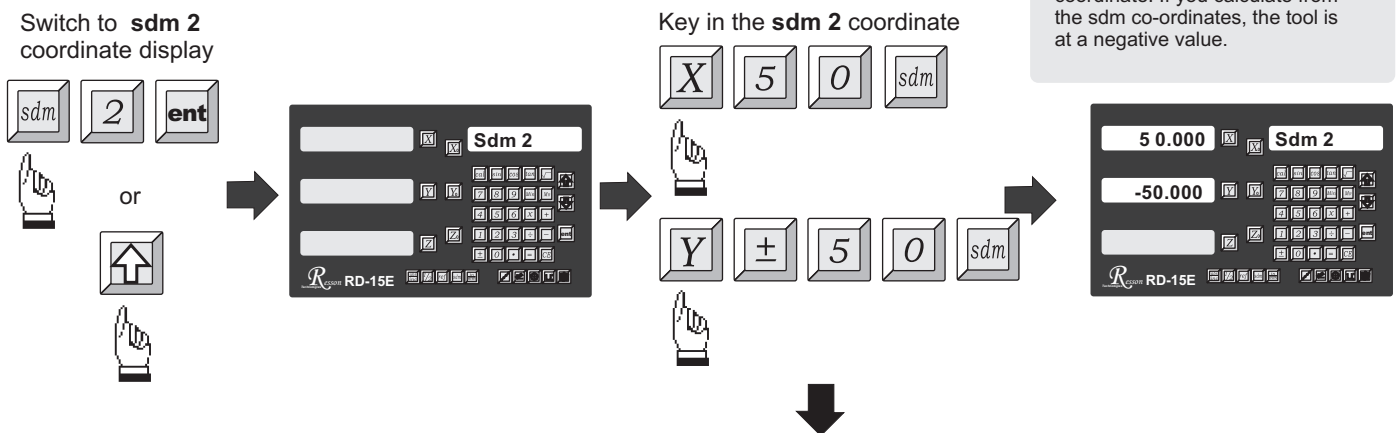

Step 4 : Set up the subdatum point 3 (sdm 3)

Switch to **sdm 3** coordinate display



or

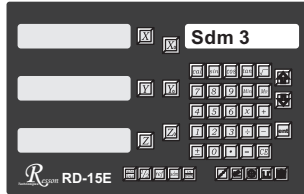

Key in the **sdm 3** coordinate

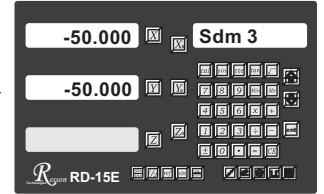
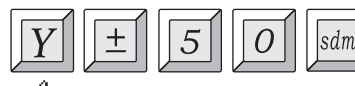

Step 5 : Set up the subdatum point 4 (sdm 4)

Switch to **sdm 4** coordinate display



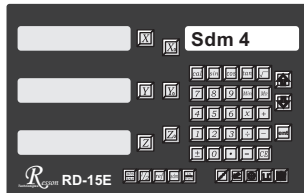

or

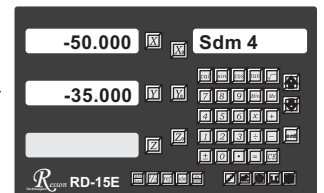
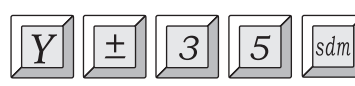

Key in the **sdm 4** coordinate



All the four subdatum points have already been set up

Operator can  or  to directly switch to the required subdatum (sdm) coordinate



Example :

switch to **ABS** coordinate display

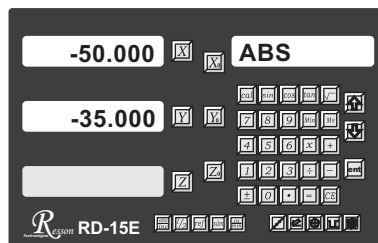

RD-15E's XY displays are referenced to the **ABS** zero

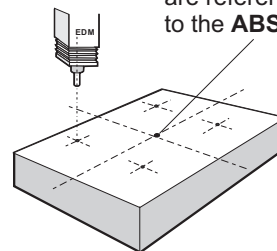

199 SubDatum function

switch to next (up)
sdm coordinate display

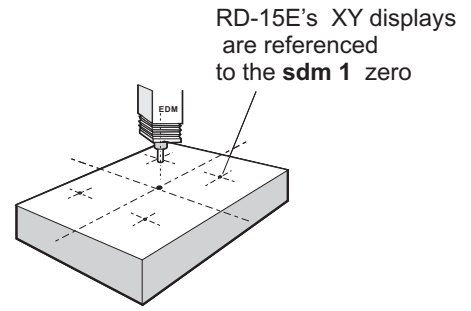
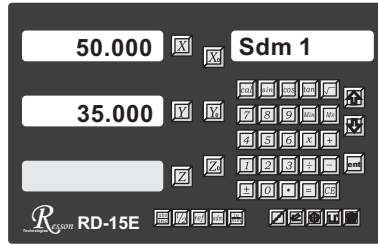
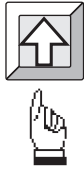

switch to next (up)
sdm coordinate display

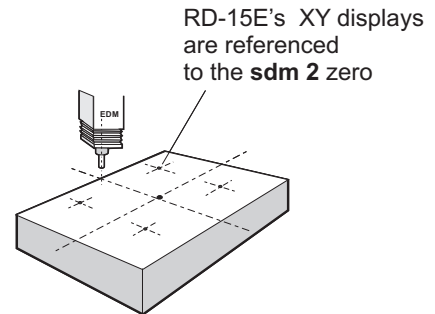
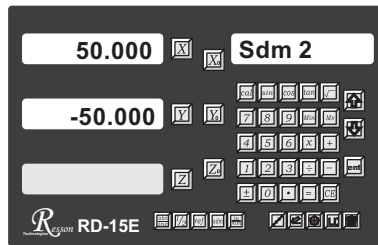

switch to previous (down)
sdm coordinate display

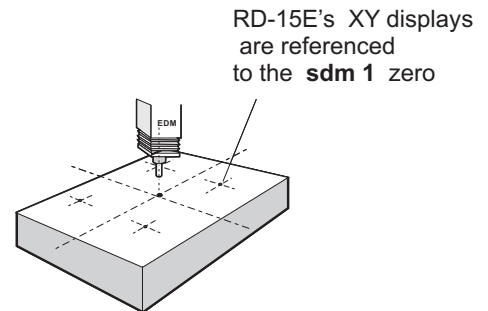
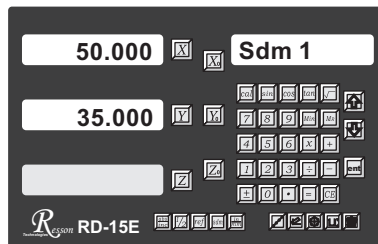

Built-in Calculator

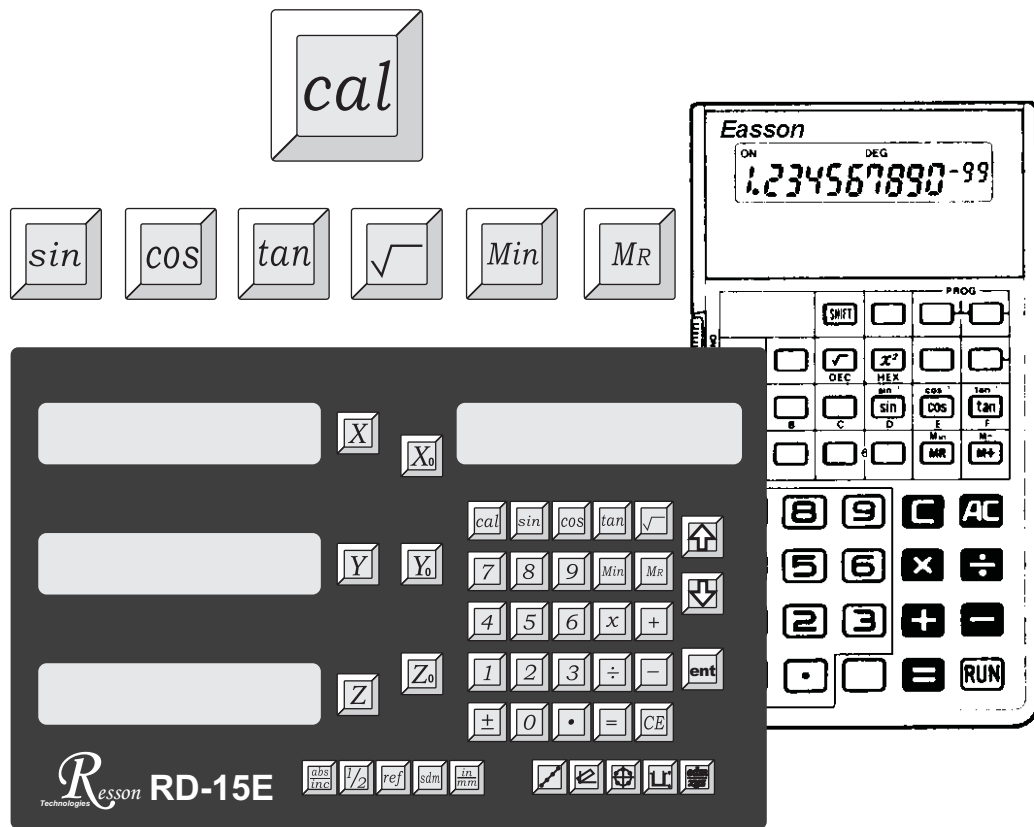

Built in Calculator

Function : A calculator is used frequently during a manual machining process..

RD-15E is the first DRO that has a built-in calculator

The built-in calculator of the RD-15E not only provides normal mathematical calculations such as add, subtract, multiply & divide, it also provides useful trigonometric calculations that are frequently required during a machining process such as **SIN, COS, TAN, SQRT** and also **inv SIN, inv COS, inv TAN, SQUARE...**

In addition a major feature of the calculator of the RD-15E is "**Result Transfer**", in that all calculated results from the calculator of RD-15E can be "transferred" to any axis to enable you to position the tool. After the result has been transferred to an axis, the RD-15E will **temporarily** preset the zero position at the calculated value, enabling the operator to simply move the machine back to axis display = 0.000, leaving the tool positioned at the calculated coordinate .

The built-in calculator offers the following advantages :

1. Operations are the same as commercially available calculators and it is easy to use ;
2. The calculated result can be directly transferred to any axis, eliminating the need to make notes of a calculation on paper, thus saving time and avoiding errors;
3. No unnecessary down-time in finding or sharing calculators whenever you need one to make calculations.

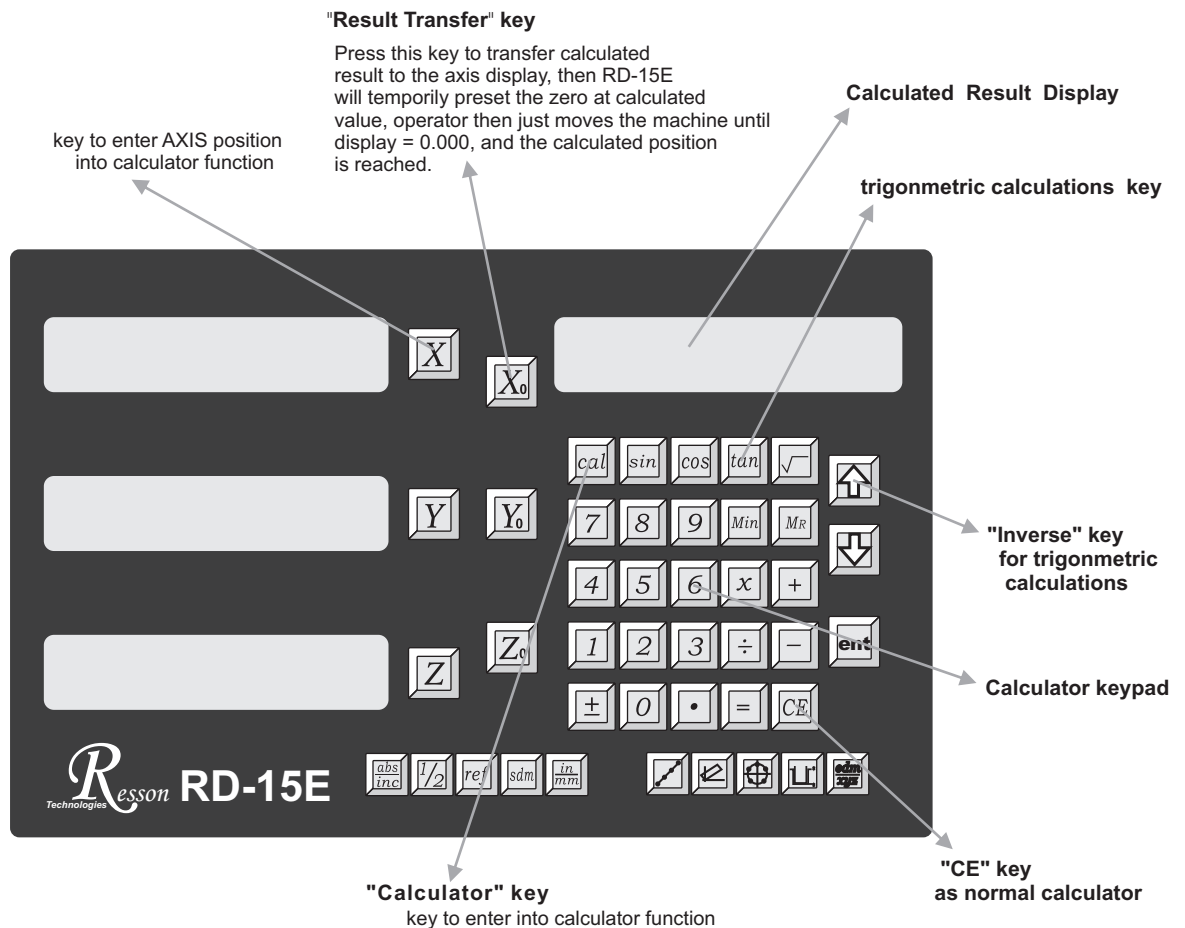

Key layout of the built-in calculator

Example :

Working principle of RD-15E's calculator function
when the RD-15E is put in calculator mode, the operation of RD-15E actually divided into two parts as follows

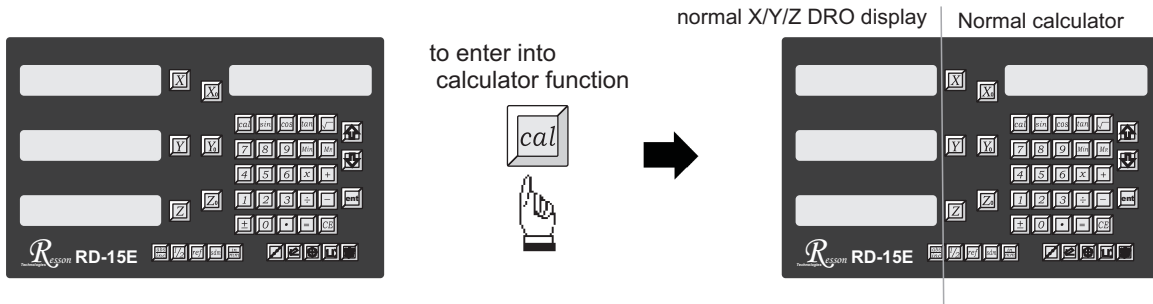

The operations of RD-15E's built-in calculator is the same as other ordinary calculators

i.e. Basic mathematics - **add ; subtract** : $78 + 9 - 11 = 76$

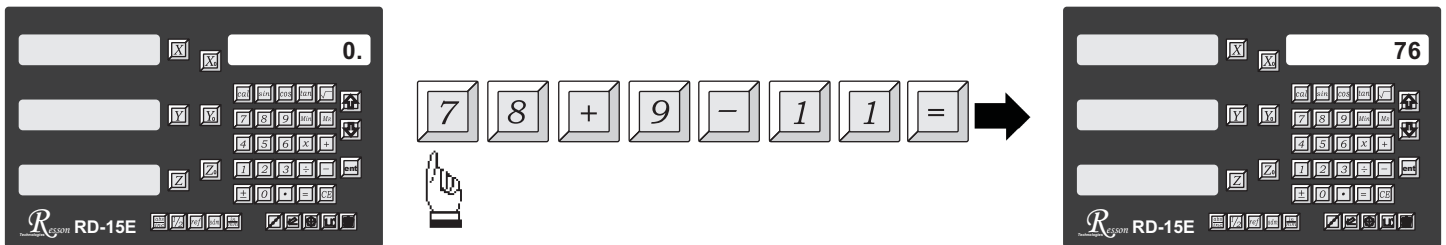

Clear - Restart the calculation

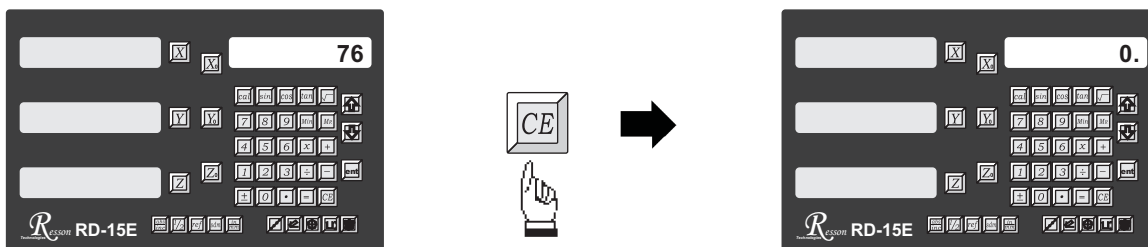

i.e. Basic mathematics - **multiply, division** : $78 \times 9 / 11 = 63.81818$

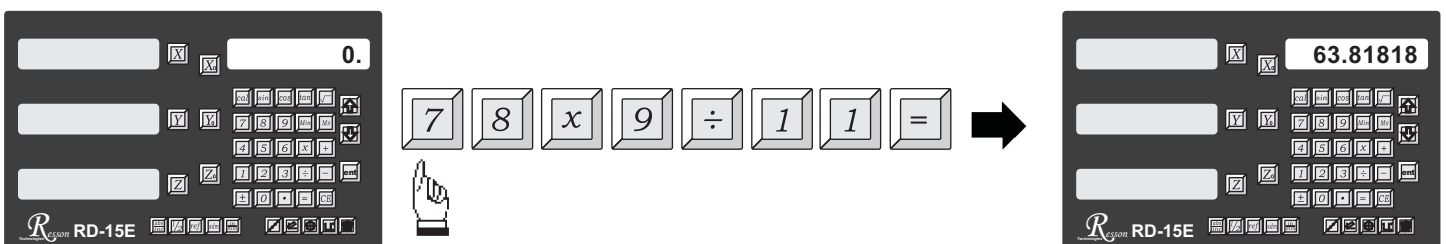

Built in Calculator

i.e. Trigonometric calculation - **COS** : $100 \times \cos 30^\circ = 86.602540$

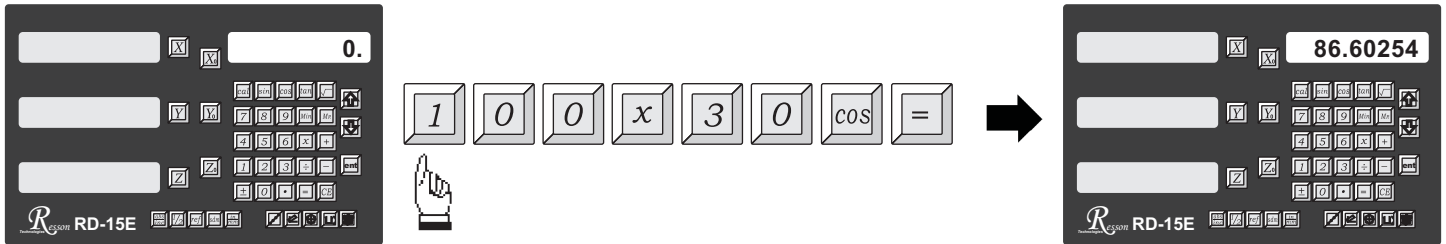

i.e. Trigonometric calculation - **inverse SIN** : $\sin^{-1} 0.5 = 30^\circ$

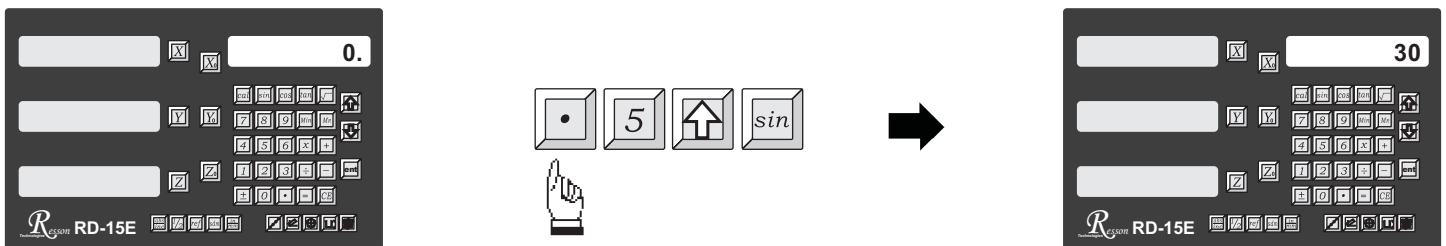

Result Transfer

i.e. : To move the tool at the position of X axis coordinate : $105 \times 1.035 = 108.675$

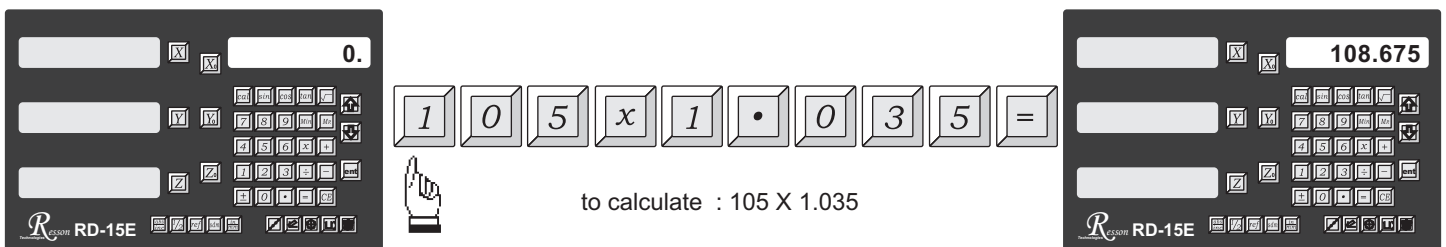

transfer the calculated result : 108.675
onto the X axis for tool positioning

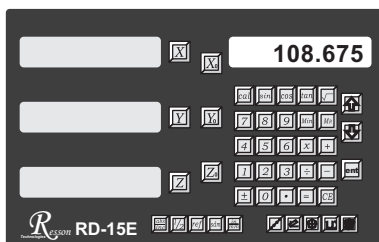

to transfer calculated
result to X axis



X axis zero position is now
temporarily preset at X = 108.675

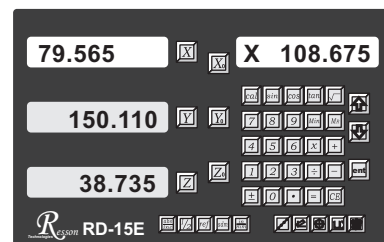

Move the machine to X display = 0.000
then it is at the position of X = 108.675

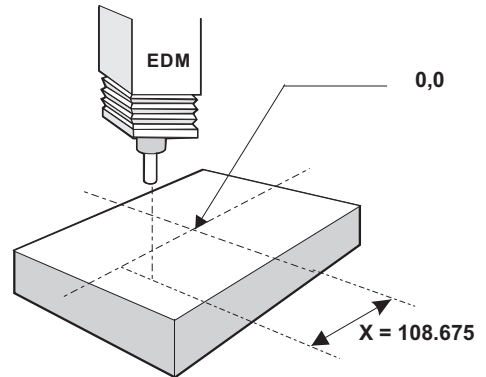
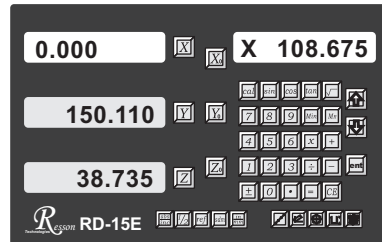

The tool is now at the position of the calculated result
(X = 108.675 in the above example)
To get back to normal coordinate display to continue
the machining



OR

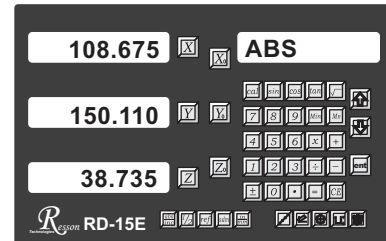
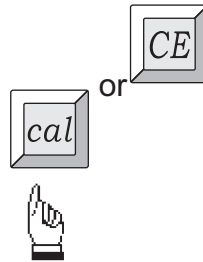
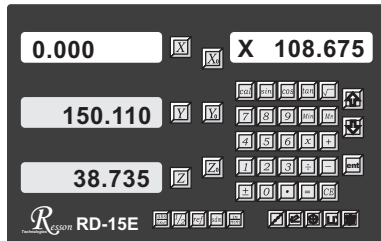

When you are in calculator mode, you can



to exit the calculator mode, to return to normal coordinate display to continue the machining.

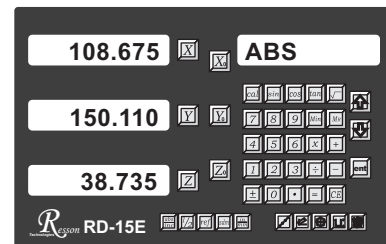
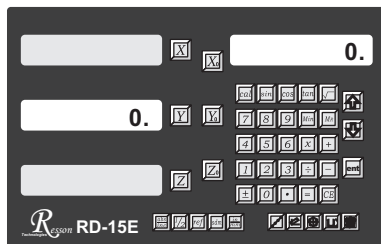

LHOLE - Tool positioning for a Line of Holes

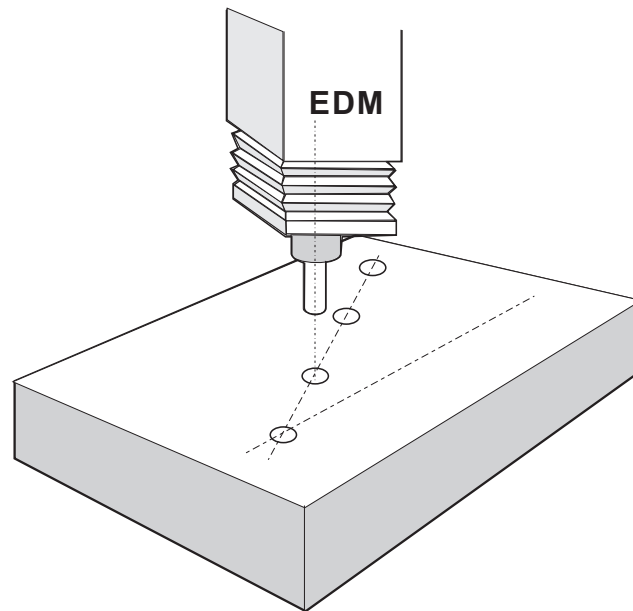
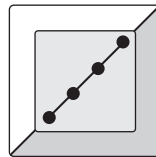

Function : RD-15E provides LHOLE function for drilling a line of holes. Simply enter the machining parameters below (following the step by step guides that are displayed on the RD-15E's message screens), and the RD-15E will calculate all the hole position co-ordinates and temporarily preset the hole position coordinates to zero (0.000). The operator then moves the machine until the display axes = 0.000, then the Line of Holes start-position is reached.

- Line Angle (**LIN ANG**)
- Line Distance (**LIN DIST**)
- No.of Holes (**NO. HOLE**)

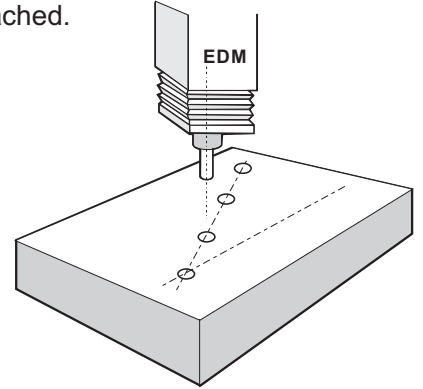

After the above machining parameters are entered into RD-15E, it presets all the Line Hole positions to 0.000

Operator can press or to select

the Line Hole, and then move the machine to display = 0.000, then the Line Hole position is reached

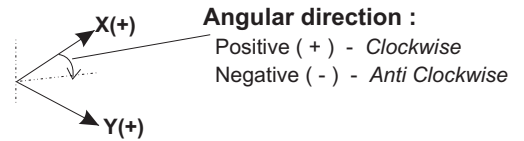

Example

Line Angle (**LIN ANG**)..... - 30 degree (Anti-clockwise)
 Line Distance (**LIN DIST**)..... 80.00 mm
 No. of Holes (**NO. HOLE**)..... 4

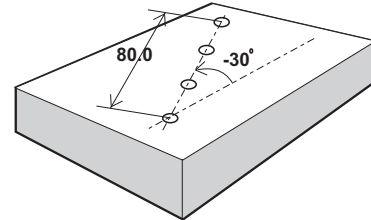

step 1 : The LHOLE function starts by using the current tool position as the starting point, therefore, locate the tool at the **first** LINE HOLE position

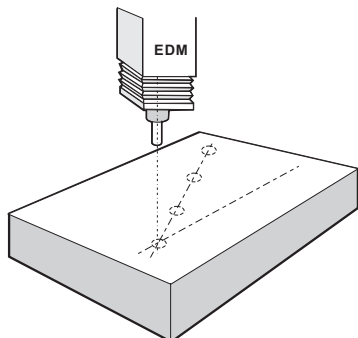

locate the tool at the **first** Line Hole position

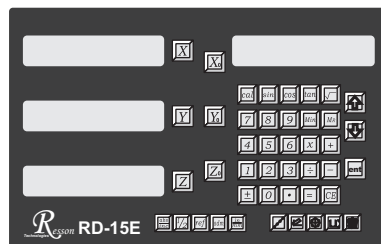

to enter the LHOLE function



enter the Line Angle (**LIN ANG**)

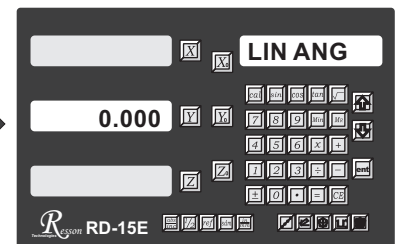

step 2 : Enter Line Angle (LIN ANG)

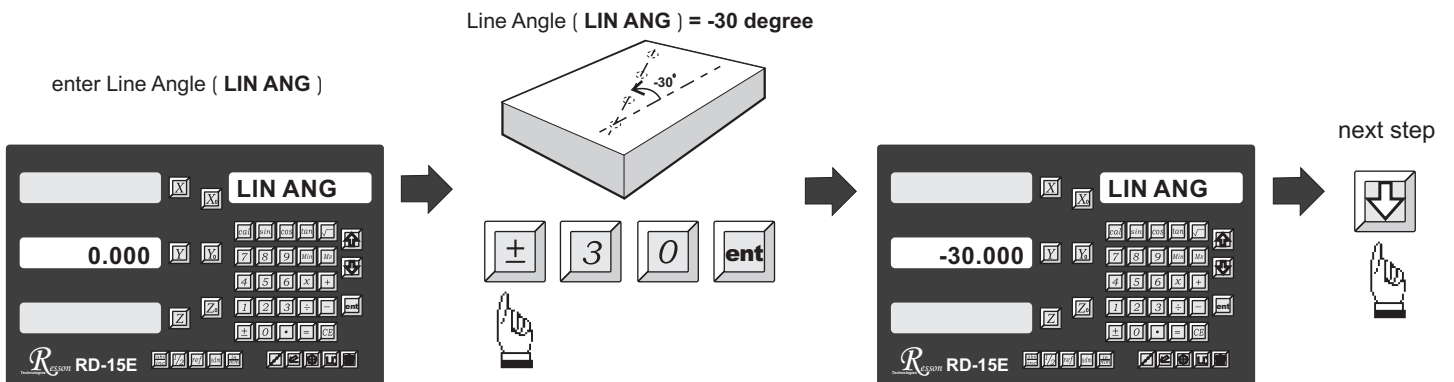

step 3 : Enter Line distance (LIN DIST)

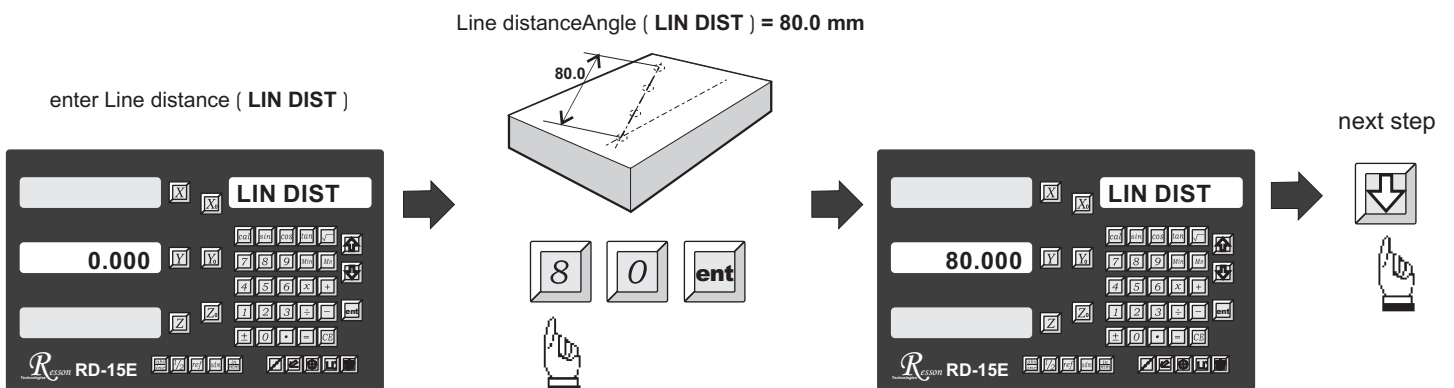

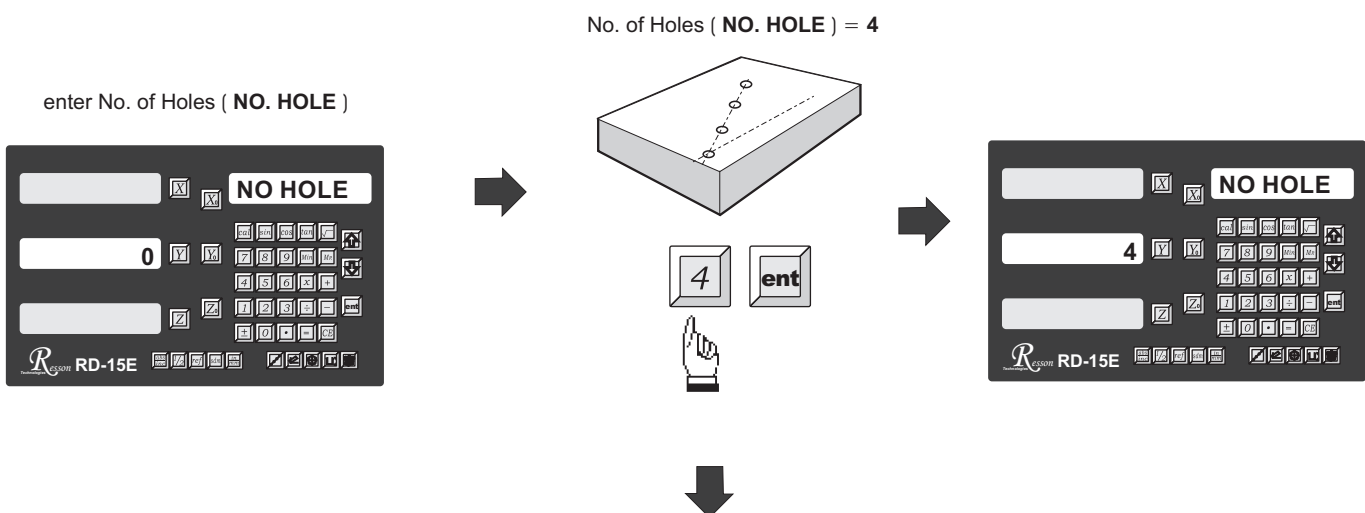

step 4 : Enter No. of Holes (NO. HOLE)



➔ All LHOLE machining parameters are already entered into RD-15E



to enter into LHOLE drilling mode

Operator can  or  to select the Line Hole, then move the machine to display = 0.000, then the Line Hole position is reached.



Next Line Hole



move the machine to display = 0.000

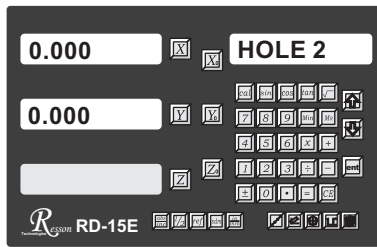

HOLE 2 = Line Hole no. 2

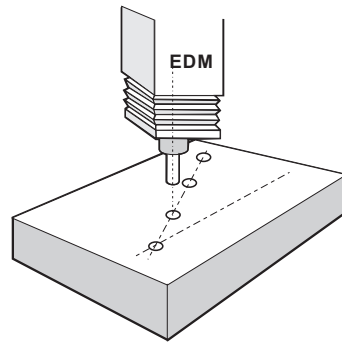

Last Line Hole



move the machine to display = 0.000

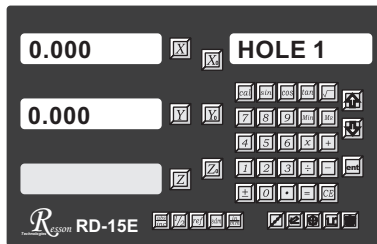

HOLE 1 = Line Hole no. 1

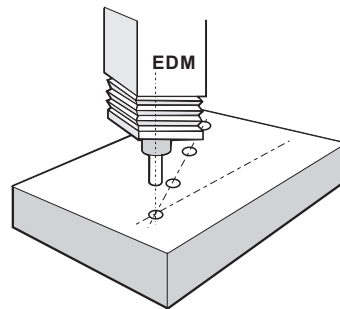

If the operator wants to check or verify that the RD-15E's LHOLE calculation is correct, or wants to temporarily exit the LHOLE function cycle (ie swap to normal XYZ display). The operation is as follows ..

presently in LHOLE cycle

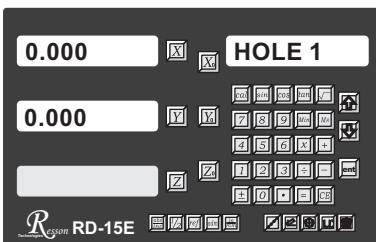

temporarily **swap** to normal XYZ coordinate display



temporarily return to XYZ coordinate display

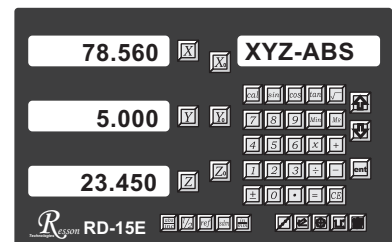

swap back to LHOLE cycle to continue the Line Holes drilling operation

presently in the temporarily
XYZ coordinate display

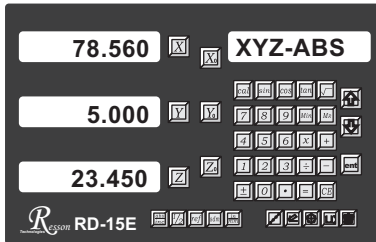

swap back to
LHOLE function cycle



return to **LHOLE** function cycle

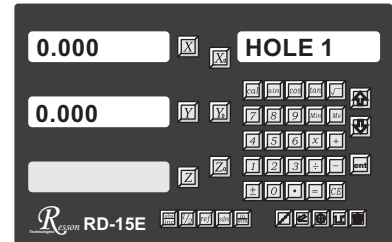

After the Line Holes drilling operation is completed, and to leave the LHOLE function cycle, follow the procedure below

presently in **LHOLE** function cycle

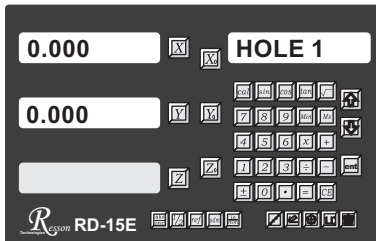

return back to normal
XYZ coordinate display

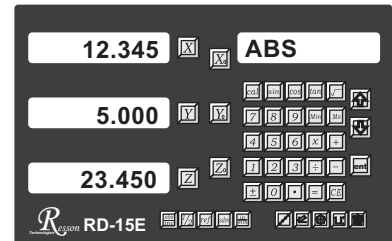

INCL - Inclined surface datum tool positioning

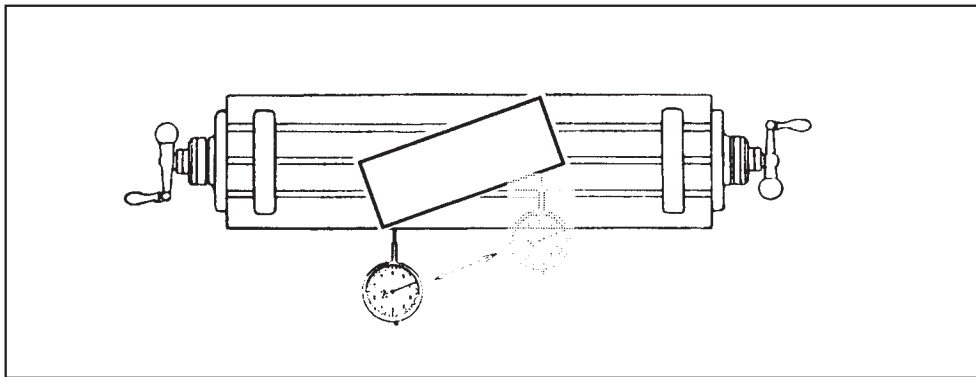
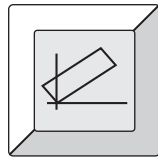

Function : During a machining process, it is quite common to machine an inclined surface.

If the work piece is small or the accuracy requirement is quite low, the operator can simply work on an incline or rotary table to machine the inclined working surface easily.

However, when the **work piece is too big** to be installed onto the incline table, or the **accuracy requirement is high**, the only solution is to calculate the machining points or datuming points using the mathematical method. This is generally very time consuming.

The RD-15E provides easy-to-use **INCL** function to help the operator for precision inclined surface datuming and machining.

A) XY plane - to accurately datum the work piece at an inclined angle

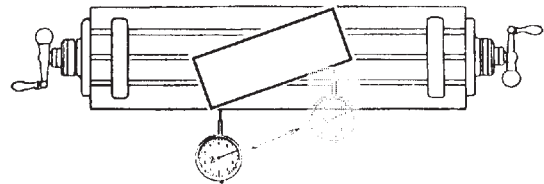

Operational procedure

Example :

To accurately datum the work piece at a 20 degree angle on the XY plane

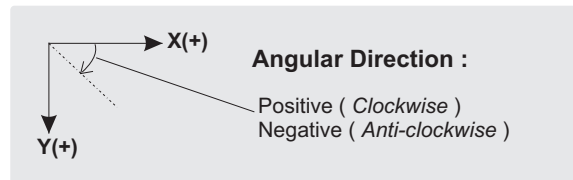

step 1 : select XY plane as the work plane (INCL - XY)

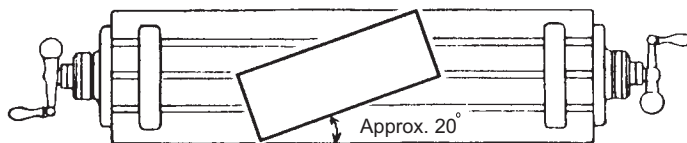

Install the work piece onto an rotary table at approxiately 20 degree.

step 2 : enter incline angle (**INCL ANG**)

enter incline angle (**INCL ANG**)

incline angle (**INCL ANG**) = -20 degree

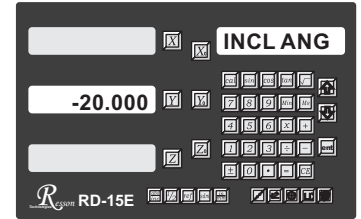
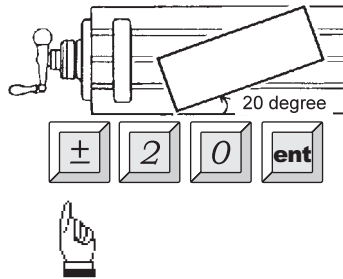
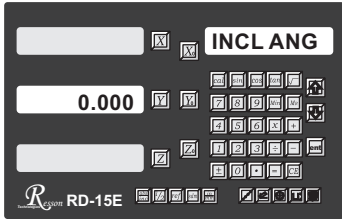

All **INCL** machining parameters already entered into RD-15E



to enter into **INCL** datuming mode



A) zero the dial indicator on one end of the work piece

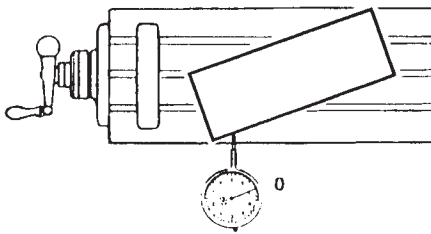

zero the RD-15E

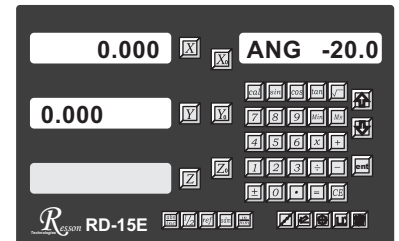

since in **INCL** mode, the Y display is set according to $X * \tan (ANG)$, therefore, zeroing the X axis also clear the Y axis.

B) After move the machine to Y axis display = 0.000, then the Y axis position is accurately posited at 20 degree. operator can fine tune the work piece incline angle until the dial indicator at zero.

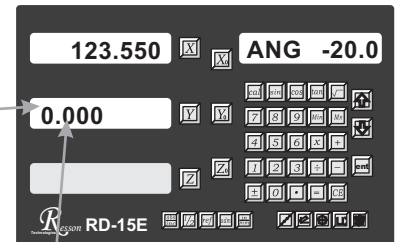
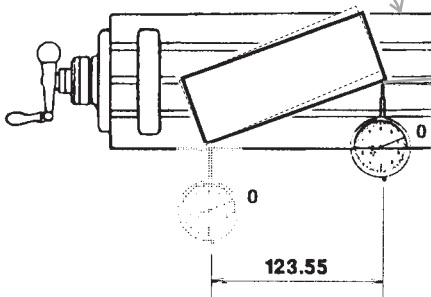

Y axis zero position will follow the X axis position at the angle of **ANG** (-20 degree in this example) operator just move the Y axis to display = 0.000 - it is then at an accurate 20 degree position

During the incline angle alignment, angular adjustment of any one end of the work piece will affect the the position on the other end, the above angular alignment procedure A) & B) has to be carried out iteratively until operator is satisfied with the angular alignment achieved.

If the operator wants to check or verify if RD-15E's INCL calculation is correct, or wants to temporarily exit the INCL function cycle (swap to normal XYZ display). The operation are as follows .:

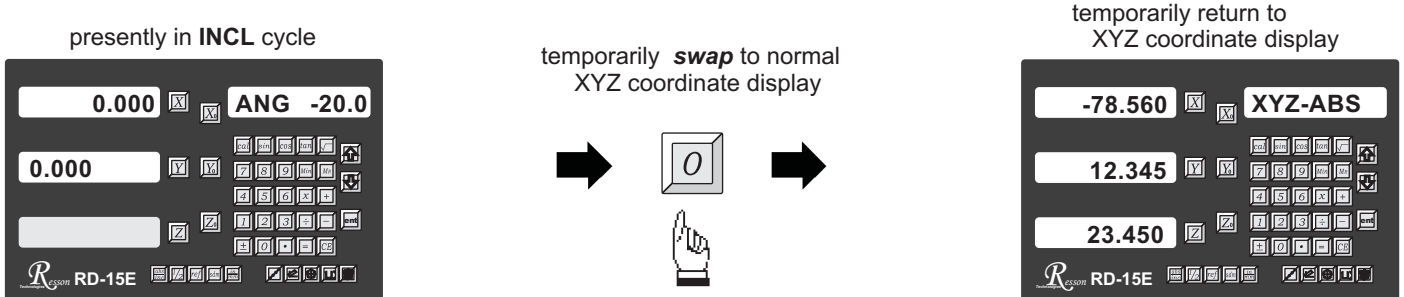

swap back to INCL cycle to continue the **INCL** incline angle alignment

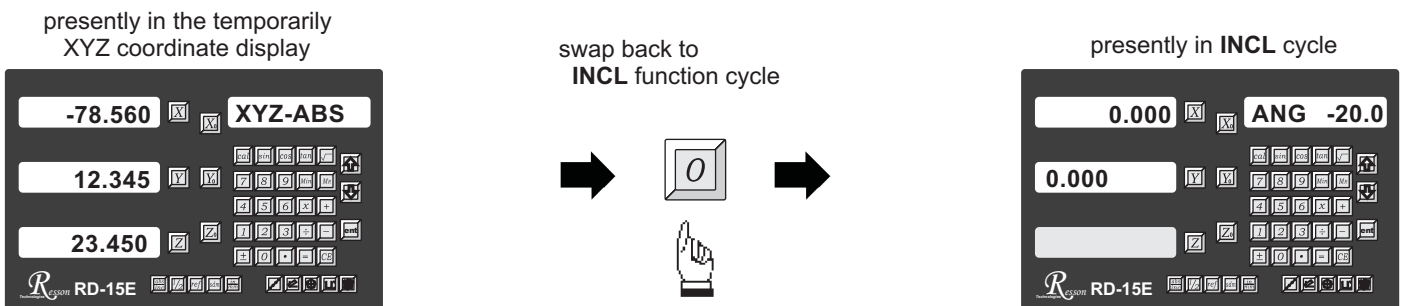

PCD - Tool positioning for Pitch Circle Diameter

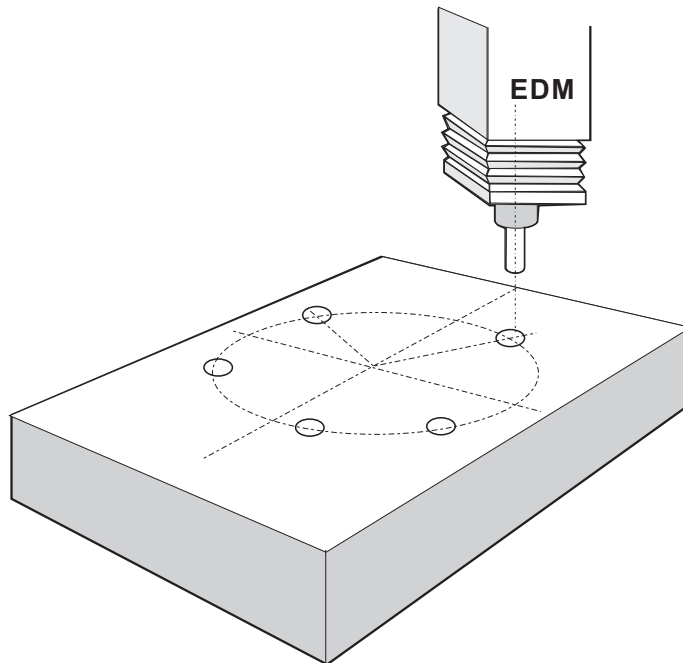
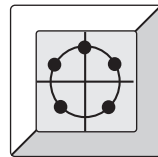

Function : RD-15E provides a PCD function to for drilling holes around a Pitch Circle Diameter. The operator simply enters the following machining parameters in accordance with the step by step guides shown on the RD-15E's message display,. The RD-15E will then calculate all the pitch hole position coordinates and temporarily preset the hole position coordinates to zero (0.000). The operator then moves the machine until the display axes = 0.000 and the pitch hole position is reached.

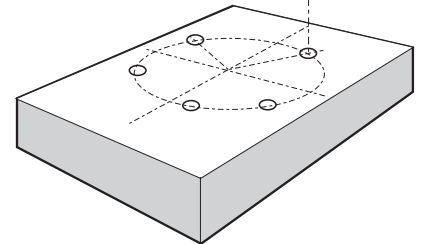
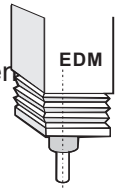

- Centre (**CENTRE**)
- Diameter (**DIA**)
- No. of Holes (**NO. HOLE**)
- Start Angle (**ST. ANG**)
- End Angle (**END. ANG**)

After the above machining parameters are entered into RD-15E, it presets all the pitch hole positions to 0.000

Operator can press or to select

the pitch hole, and then move the machine to display = 0.000 - the pitch hole position is then reached

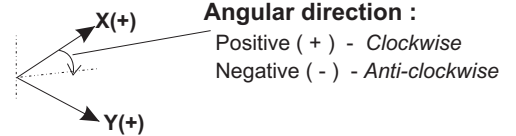

Example

Centre Coordinate (**CENTRE**) **X= 0.000, Y=0.000**
 Diameter (**DIA**) **80.000mm**
 No. of Holes (**NO. HOLE**) **5 holes**
 Start Angle (**ST. ANG**) **30 degree** (clockwise)
 End Angle (**END. ANG**) **300 degree** (clockwise)

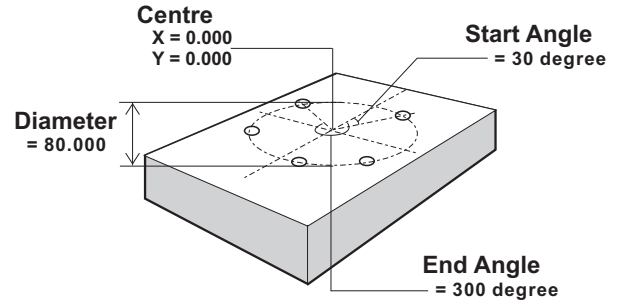

step 1 : Set up the work piece datum (work piece zero) to enter the **PCD** function

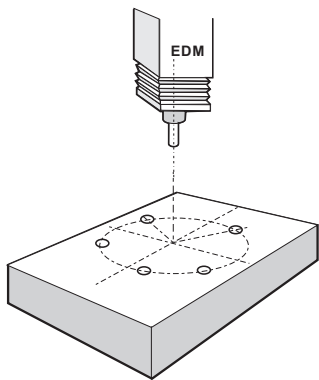

set up work piece datum

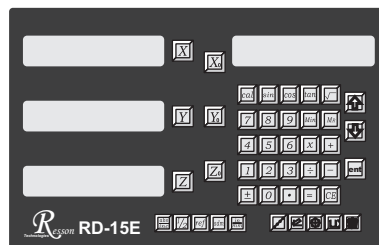

to enter the **PCD** function

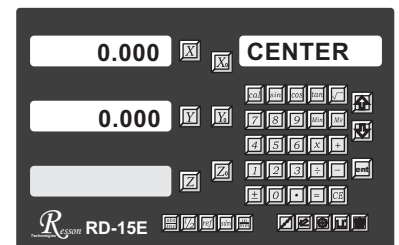

enter the **CENTRE** coordinate

step 2 : Enter Centre Coordinate (CENTRE)

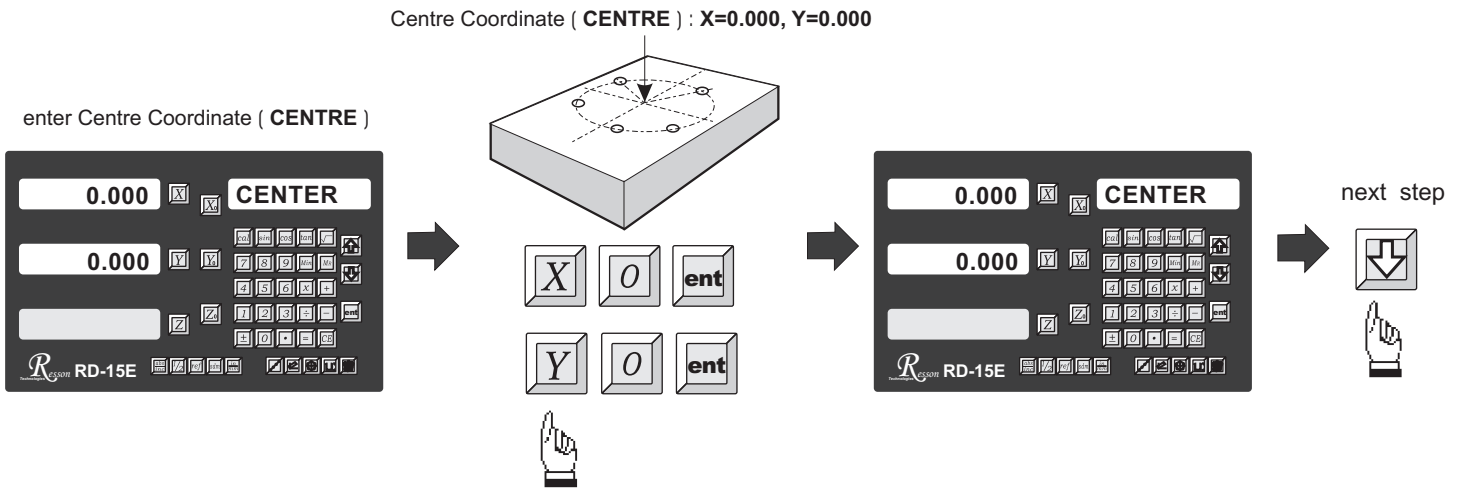

step 3 : Enter Diameter (DIA)

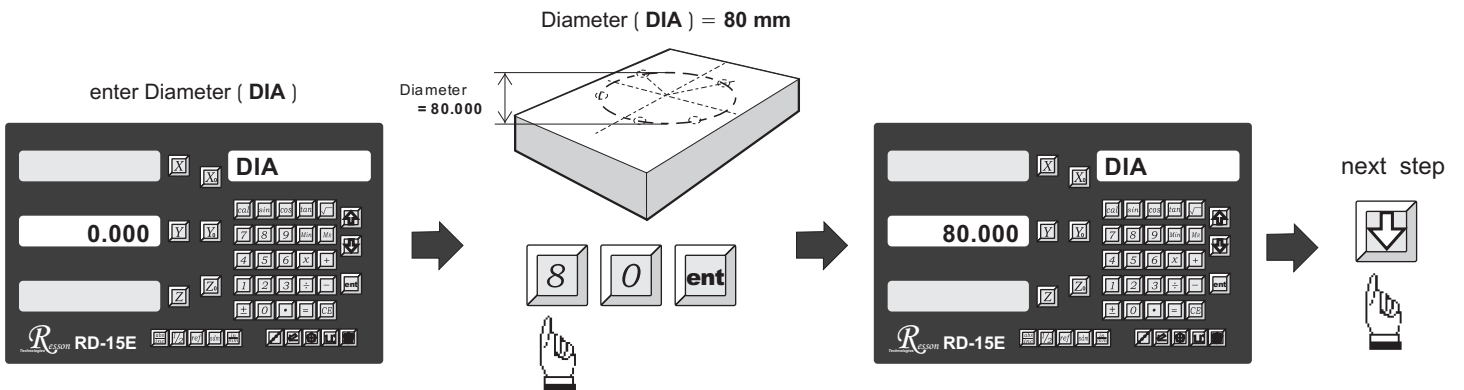

step 4 : Enter No. of Holes (NO. HOLE)

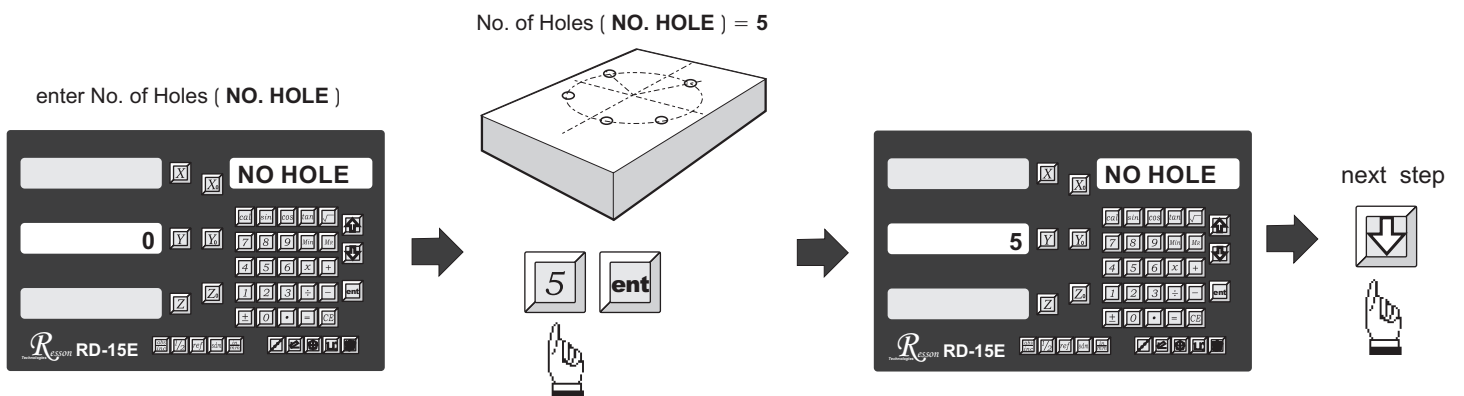

step 5 : Enter the Start Angle (ST. ANG)

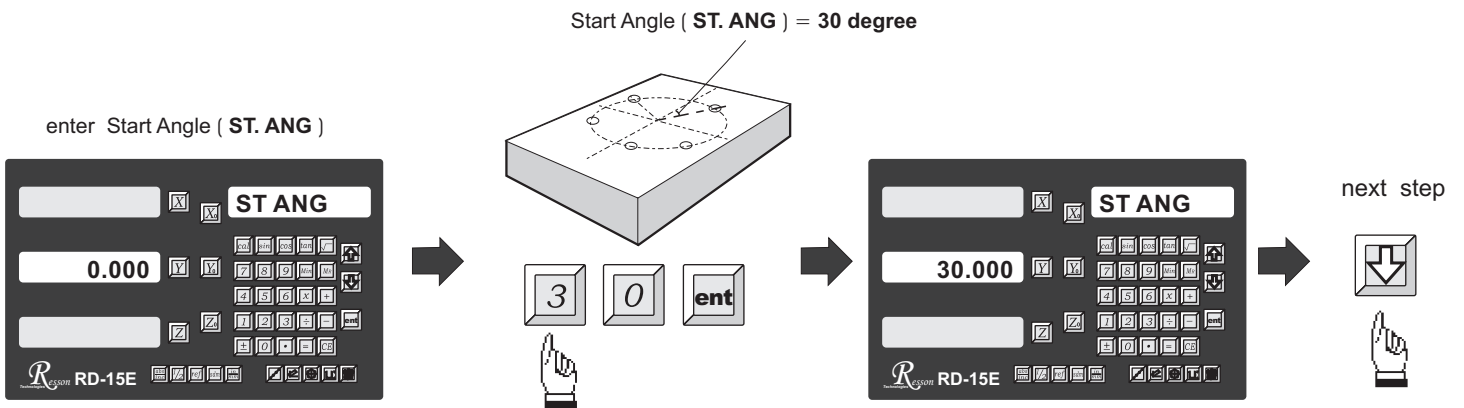

step 6 : Enter the End Angle (ENd. ANG)

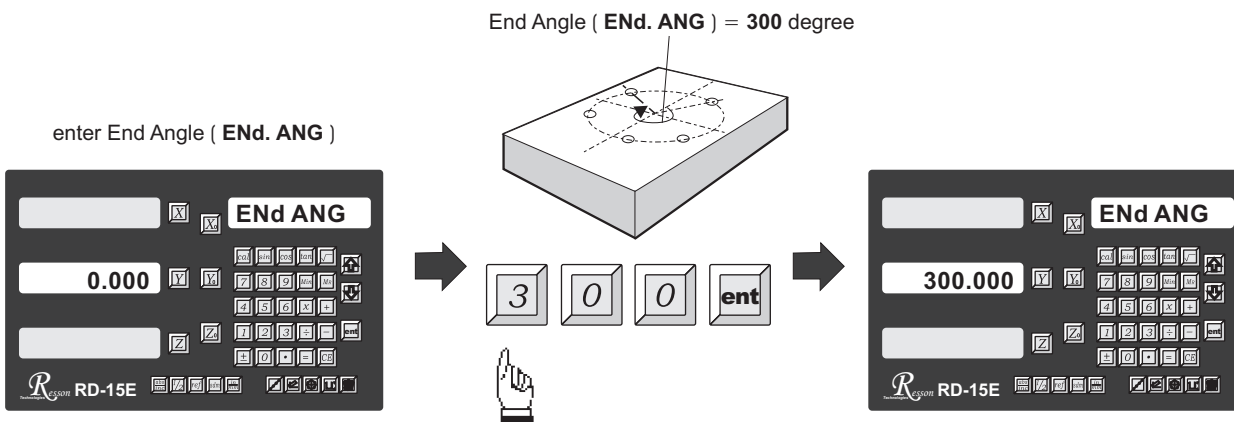

All PCD machining parameters are already entered into RD-15E to enter into PCD drilling mode

Operator can or to select the pitch hole, then move the machine to display = 0.000, to reach the pitch hole position

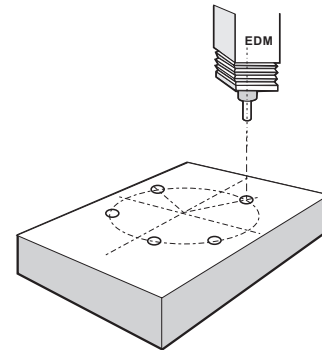
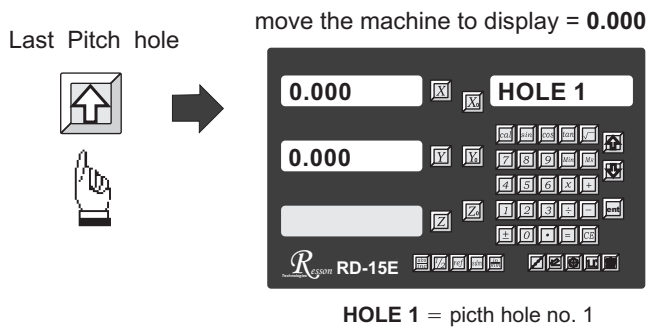
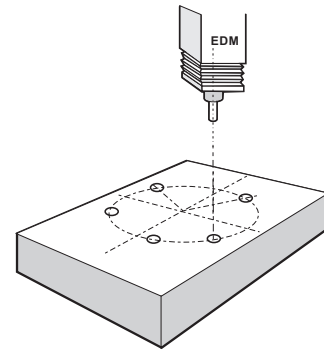
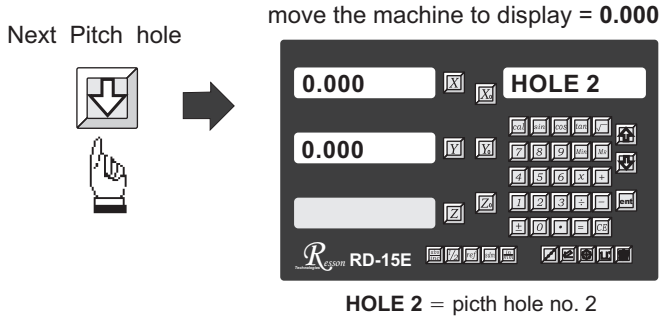

Anytime the operator wants to check or verify that the **PCD** calculation is correct, or wants to temporarily exit the **PCD** function cycle (swap to normal XYZ display).
The operations are as follows :

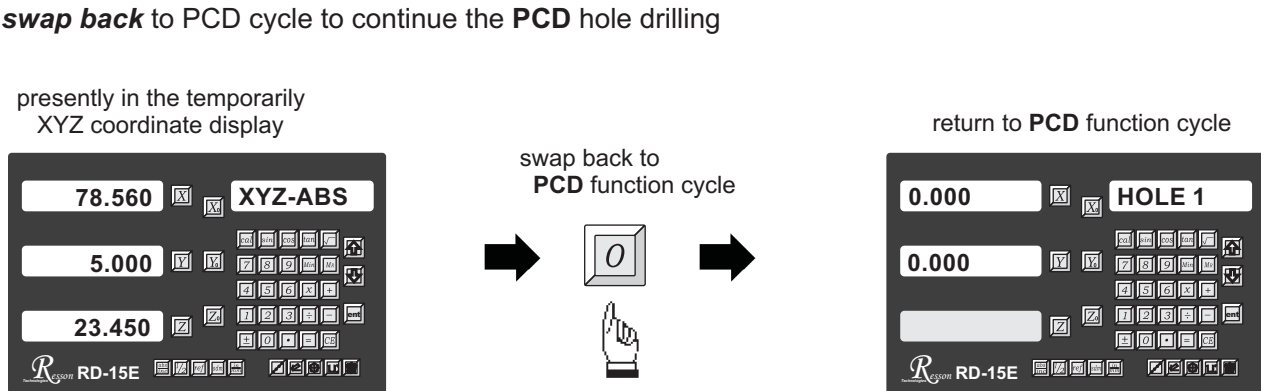
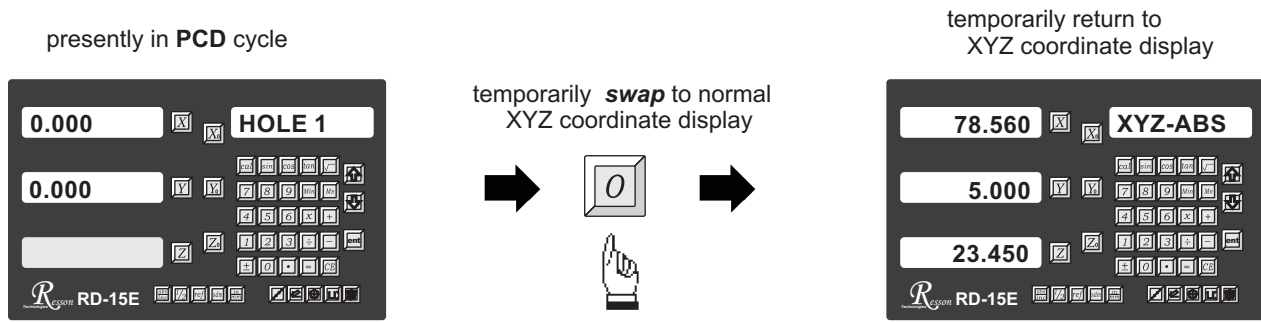

To leave the PCD function, after the PCD hole drilling operation is completed follow the under-mentioned procedure:

presently in **PCD** function cycle

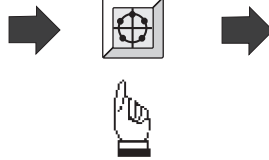
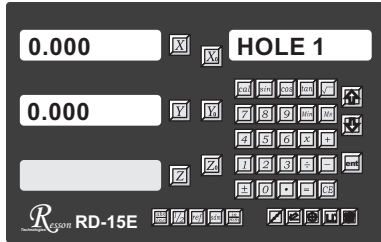

returns to normal
XYZ coordinate display

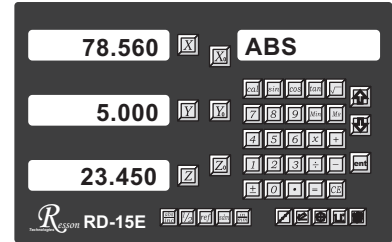

EDM Function

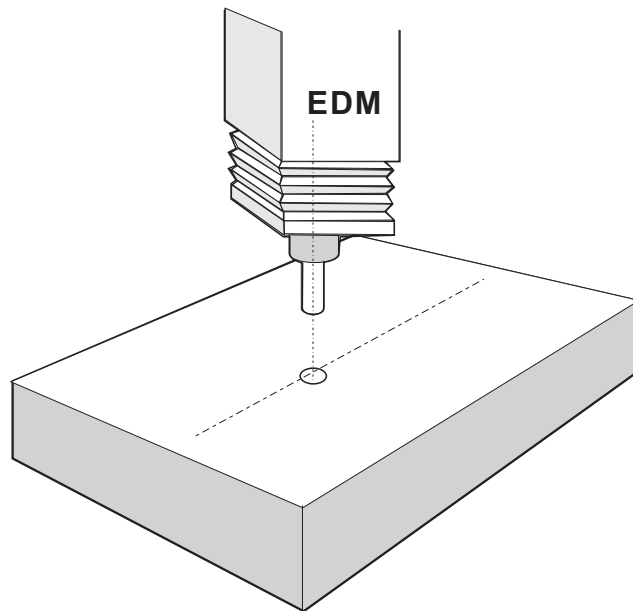
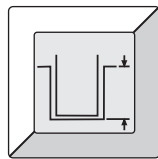

EDM function :

RD-15E provides the most complete function on EDM (electric discharge machine)

- EDM professional display
- Single-step machining
- Multi-step machining

EDM Professional Display

During the electric discharge process, X and Y Axis do not move, only Z Axis moves up and down continuously, so the most important thing is to control the machining depth of Z Axis electrode during the whole process for operators.

But, if Z Axis moves up and down continuously, for operators it is hard to assess the depth that current electrode has machined, in order to easily know the depth of current electrode, RD-15E provides the EDM professional display.

EDM professional display for single-step machining

EDM display model

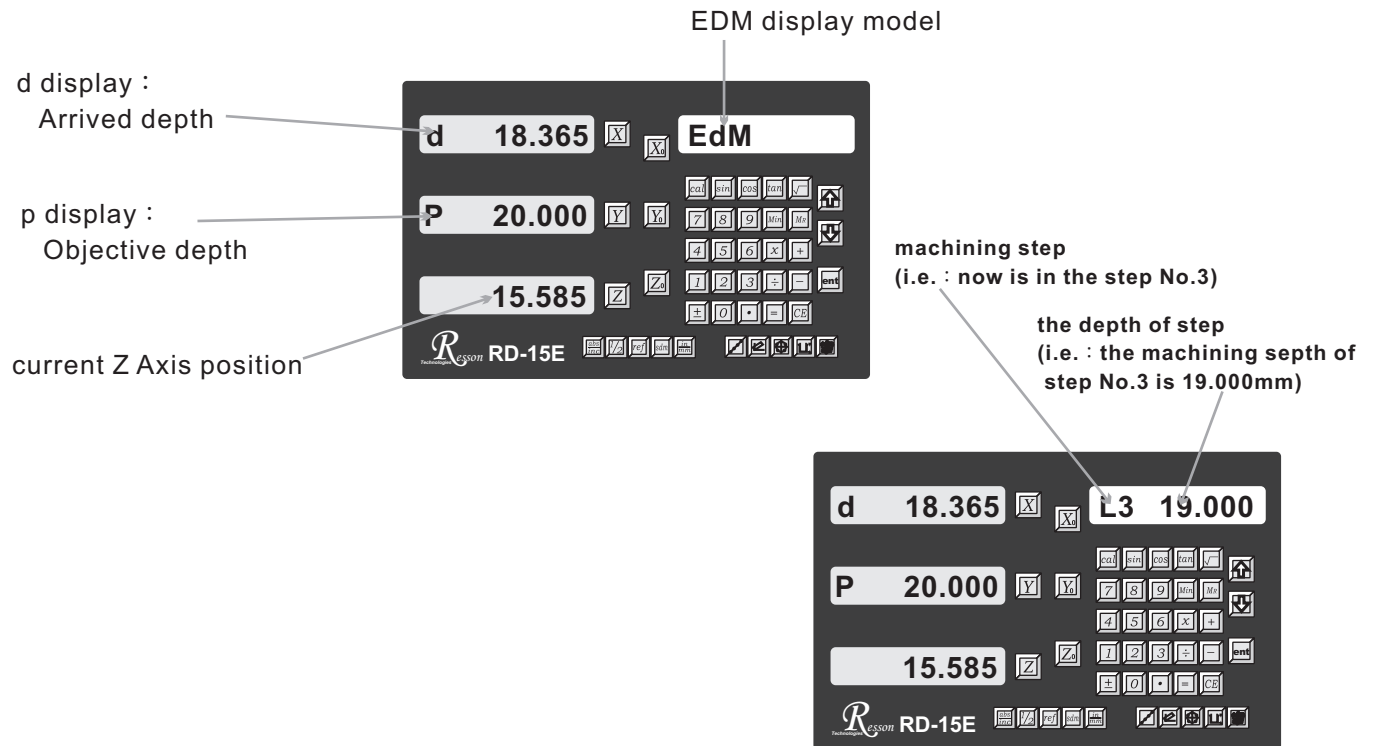

d display :
Arrived depth

p display :
Objective depth

current Z Axis position

machining step
(i.e. : now is in the step No.3)
the depth of step
(i.e. : the machining septh of step No.3 is 19.000mm)

Currently RD-15E is in the normal XYZ display, if want to switch to EDM professional display, please press



Currently RD-15E is in EDM professional display, if want to switch to the normal XYZ display, please press



Example : The machining depth of workpiece is 30.000mm
(the surface of workpiece is zero position)

RD-15E provides the easiest function to stop automatically, when electrode arrived the objective depth, RD-15E will appear a message to stop the EDM.

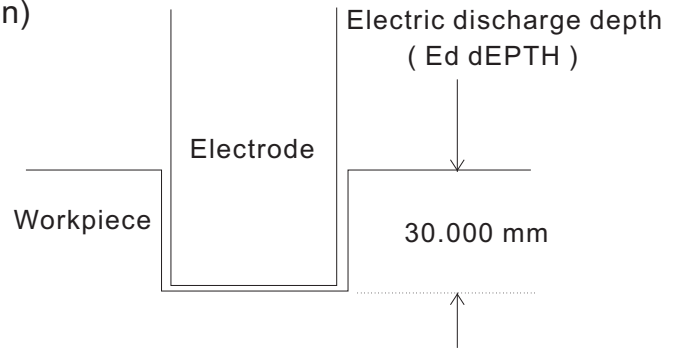

Example : Electric discharge depth (Ed dDEPTH) = 30.000mm

Operation procedure

Step 1 : Enter into the EDM function

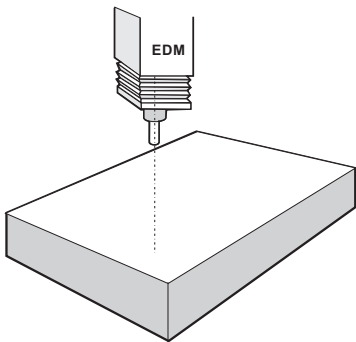

set up surface of workpiece :
Z = 0.000mm

to enter the EDM setting function

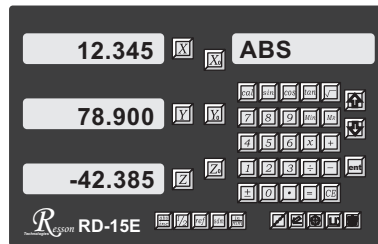

enter the electric discharge depth (Ed dDEPTH)

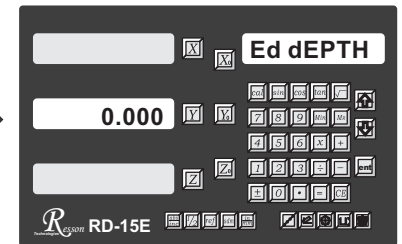

Step 2 : Enter the electric discharge depth (Ed dDEPTH)

enter the electric discharge depth (Ed dDEPTH)

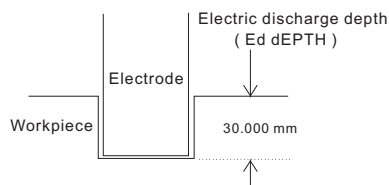

set up the electric discharge depth completely RD-15E enter into the EDM professional display automatically, and start machining immediately.

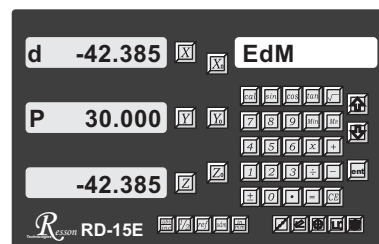
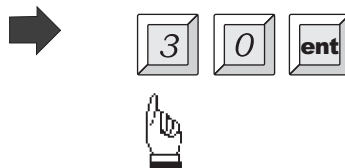
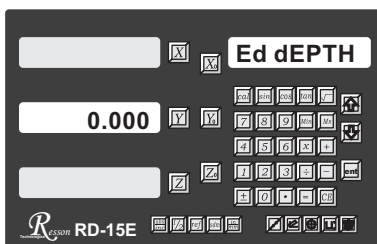

Step 3 : Start the EDM to machine

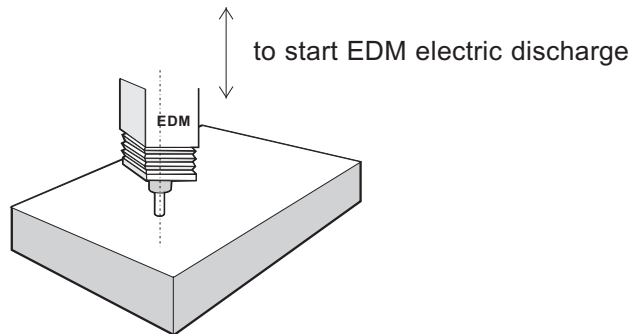

Operators want to check the XYZ positions to assure the XY positions are not moved during the machining process, or in order to compensate the error that the losing of electrode caused, operators must change the depth of Z Axis, so RD-15E provides a simple switch to help operators to machine easily, check and change the depth.

Currently RD-15E is in EDM professional display, if want to switch to the normal XYZ display, please press



Currently RD-15E is in the normal XYZ display, if want to switch to EDM professional display, please press



When (d display) machines to (p display), it means that the objective depth has arrived, RD-15E will appear a message to stop and lock the EDM, and RD-15E appears the following display, it means the electric discharge has completed.

Step 4 : After the EDM machining completed, the procedure as follows

when d display arrives to p display, it means the electric discharge has completed, and RD-15E will stop and lock the EDM.

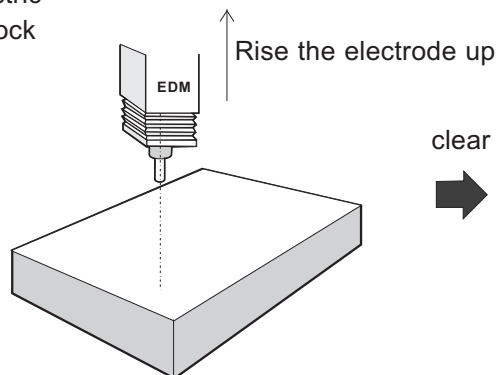
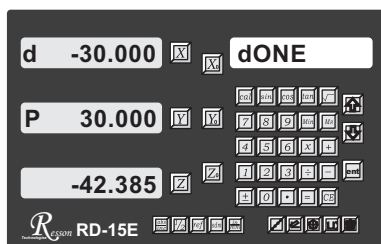

clear the lock of Z Axis



Note :

When RD-15E is in the normal XYZ display, even if Z Axis has arrived the objective electric discharge depth (Ed DEPTH), RD-15E will not stop the EDM, This design is to make operators set up Z Axis zero point at will, and cannot be limited by last machining depth.

RD-15E provides a **DB9** connecting socket for external control purpose, the pin assignment as below :

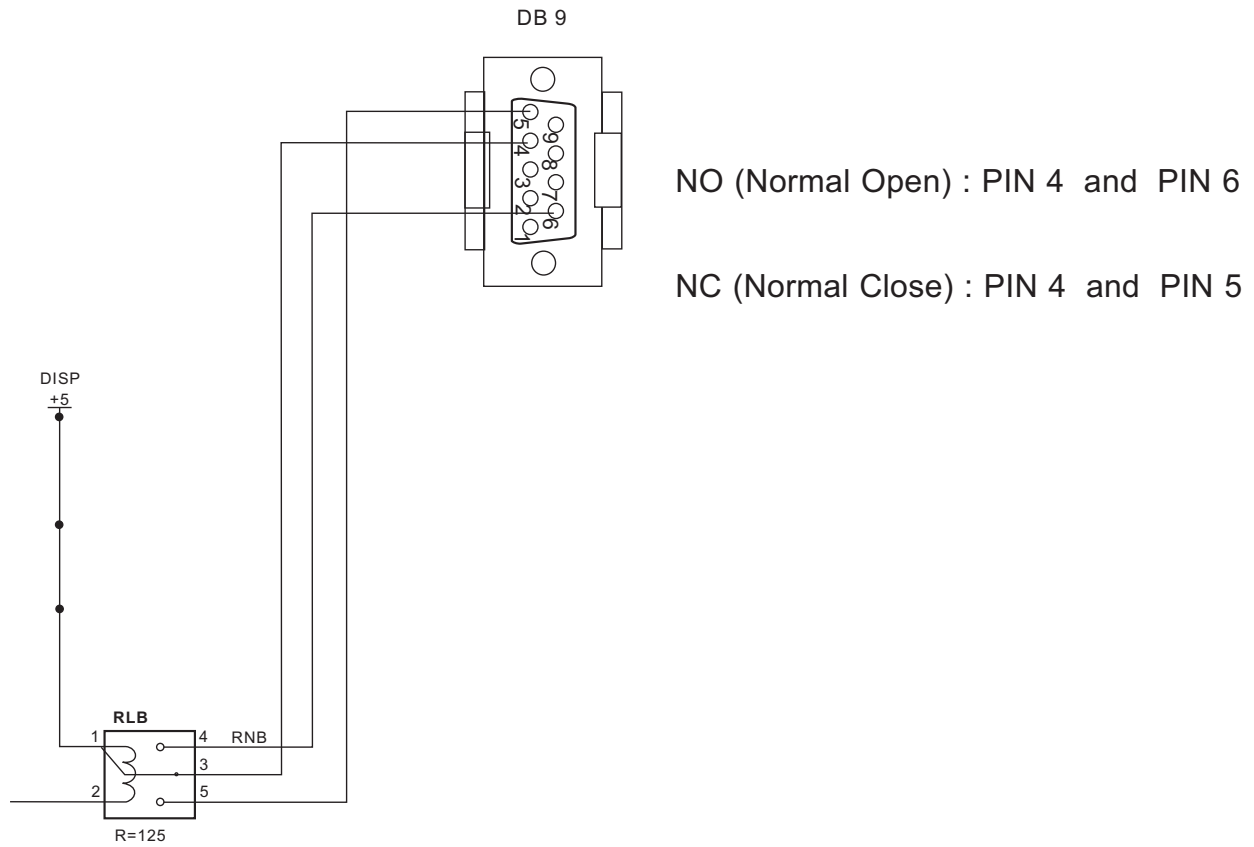

RD-15E Parameters Setup

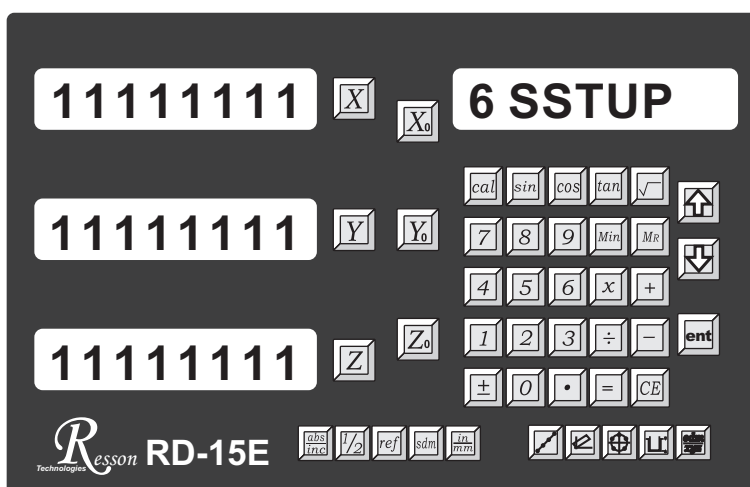

- BAUD SET set up RS232 transmission baud.
- BEEP ON/OFF turn on/off printer.
- BEEP ON/OFF turn on/off beeper.
- RESOLUTE set up Linear scale resolution.
- CP ERROR compensate Linear scale error
- LINEAR P compensate linear error.
- NL ERROR compensate nonlinear error (point compensation)
- DIRECT set up direction.
- EXIT end and exit.

Reset display's original parameter (RESET)

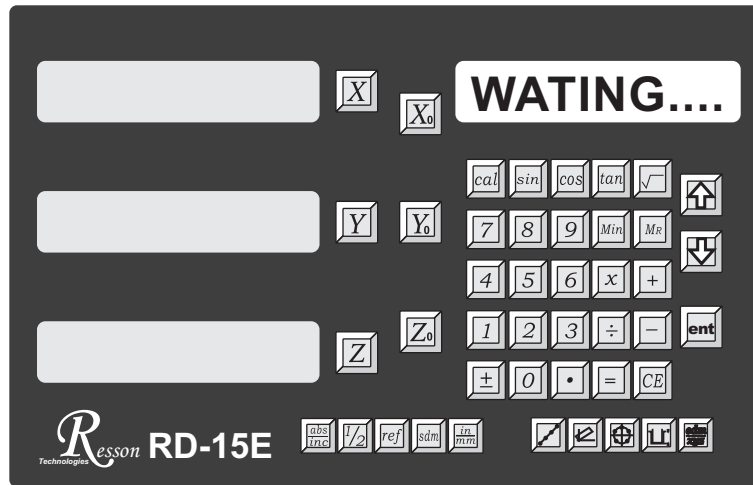

When the DRO is under the impact of abnormal voltage, or user's improper operation that cause parameter setting in error, it needs to default simple working parameters by resetting them to default value from memory. Yet, before parameter reset, check if there is any parameter value set in already; if so, write down the setting data and set it up after reset.

Operation steps:

- 1) . Turn off the DRO power.
- 2) . Turn on the DRO; when “11111111” test signal is shown in the display window, press “0” and the display start performing “reset”.

While turning on the display,
it will perform self diagnosis
and test; press

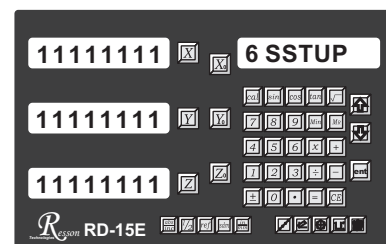

- 3). 1. When parameters reset, “WAITING” will show on the display.

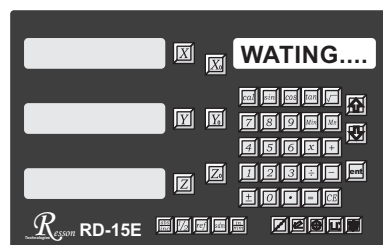

“WAITING --” is shown as
parameter reset is underway.

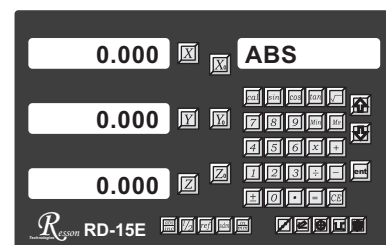

After coming backing to normal mode,
the parameter reset process is complete.

Set up new parameters in display (SETUP)

When DRO-change IC is under the impact of abnormal voltage or improper operation, which cause the default disturbed; or user wants to change production process and needs to modify the default value, it needs to set up DRO and reset function values in memory.

DRO in the display and related key locations in the SETUP process:

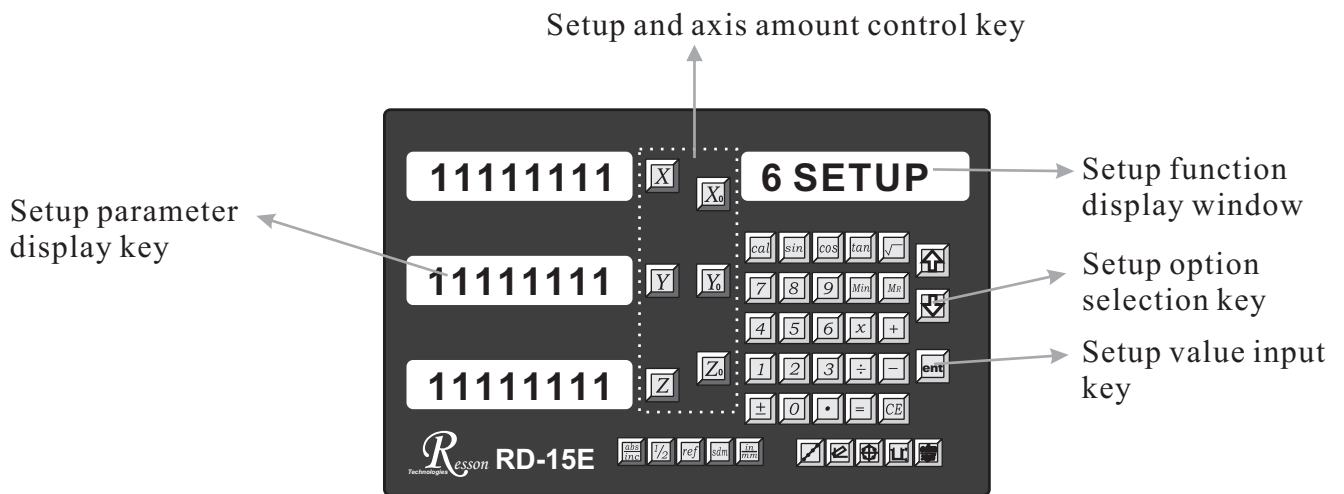

Operation steps:

- 1) 1. Turn off the DRO power.
- 2) Turn on the DRO; when self-diagnosis test signal is shown in the display window, press  and the display start performing “setup”



The setup procedure is designed to option menu mode; the Definition List facilitates user to apply the following options.

The first layer functions are, in turn, defined as below:

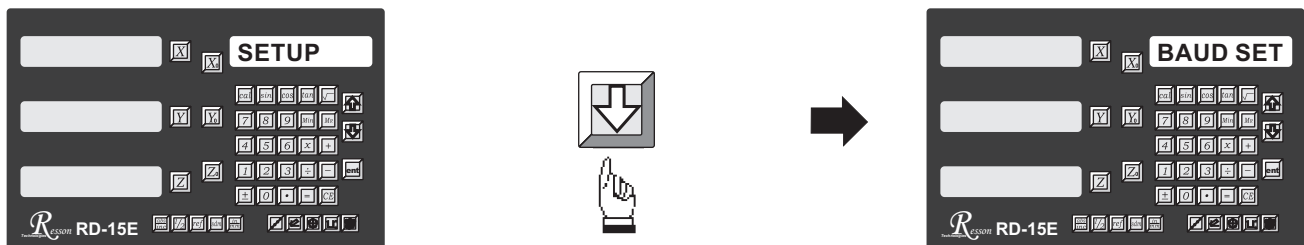

- BAUD SET set up RS232 transmission baud.
- BEEP ON/OFF turn on/off printer.
- BEEP ON/OFF turn on/off beeper.
- RESOLUTE set up Linear scale resolution.
- CP ERROR compensate Linear scale error
- LINEAR P compensate linear error.
- NL ERROR compensate nonlinear error (point compensation)
- DIRECT set up direction.
- EXIT end and exit.

3) Press  to “BAUD SET”.

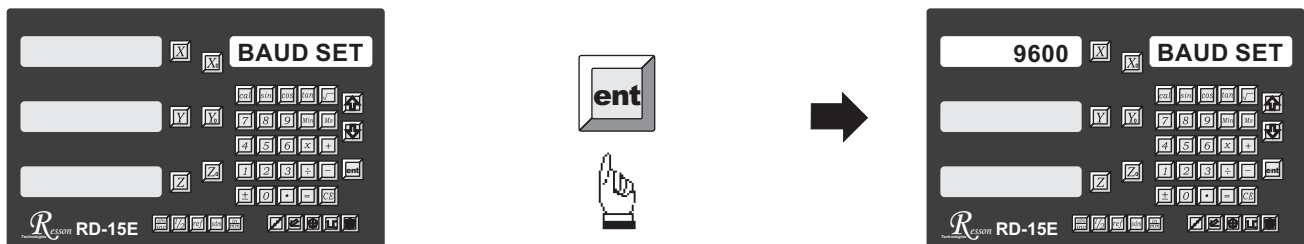

Press  to enter the setting of RS232 transmission baud.



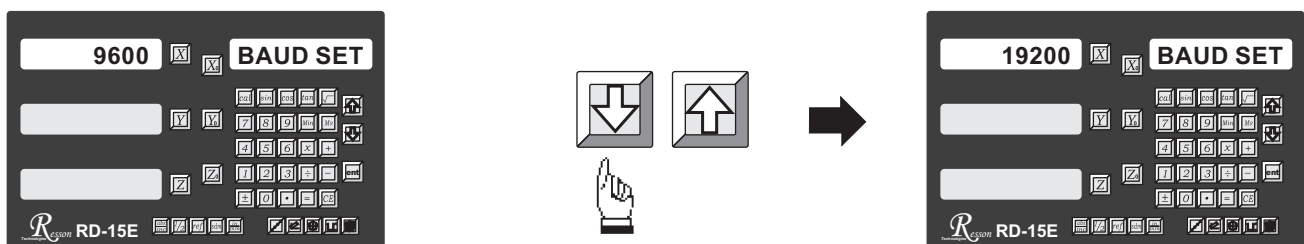

Press  or  to select the correct baud speed from 1200/2400/4800/9600/19200/57600.



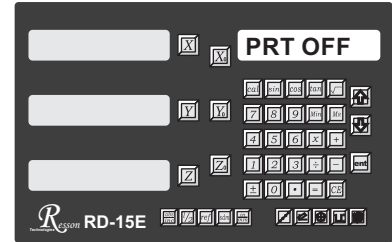
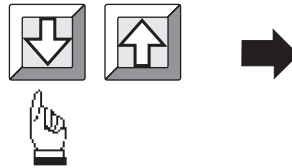
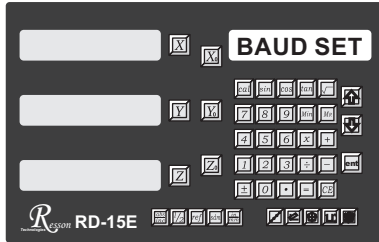

After baud speed is selected, press  to end up this setting function.

4) Press  or  and move to “PRT ON/OFF”.

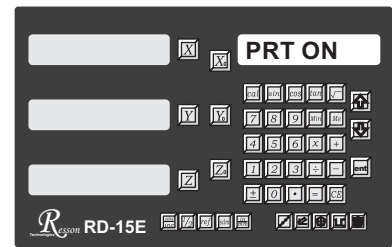
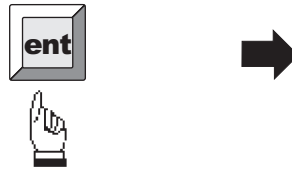
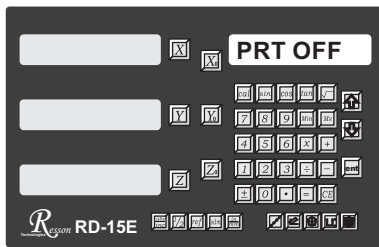

Directly press  to change over OFF & ON.



5) Press  or  and move to “BEEP ON/OFF”.

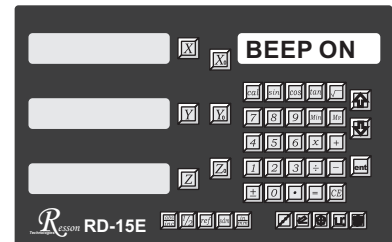
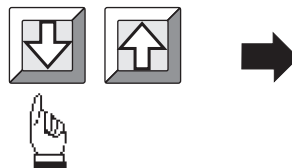
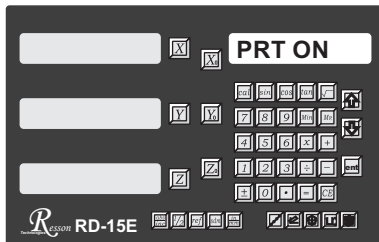

Directly press  to change over OFF or ON.

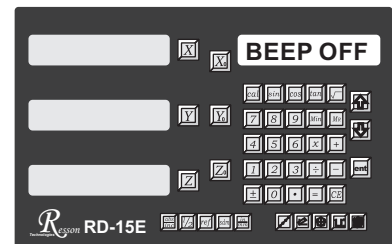
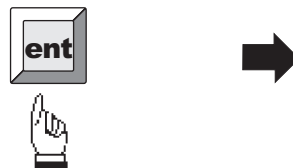
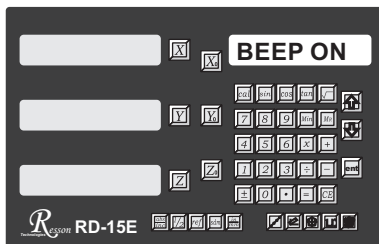

6) Press or and move to “RESOLUTE”.

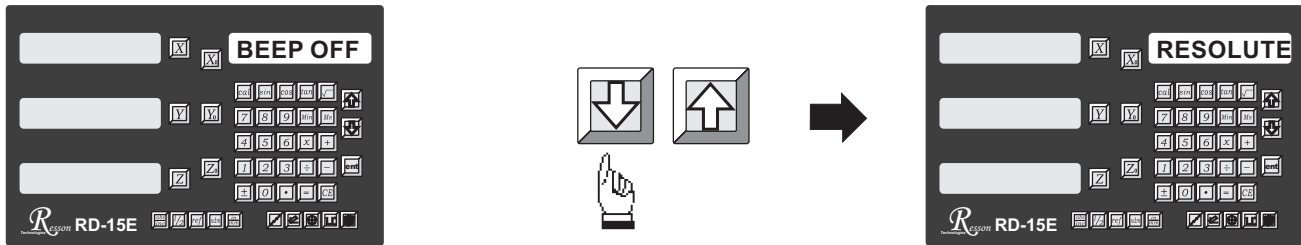

Press to enter the linear scale resolute setup.

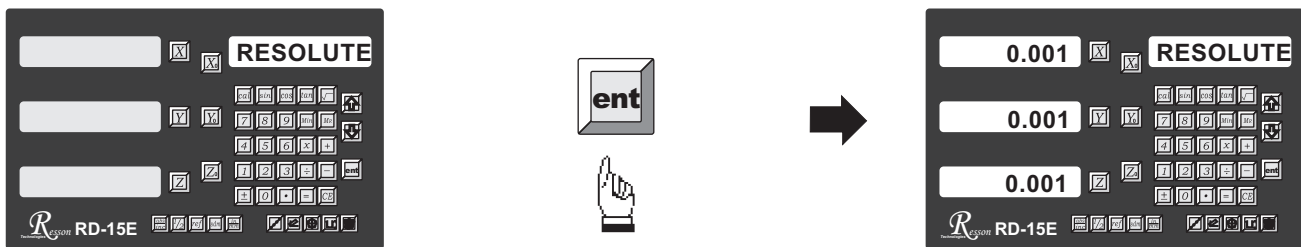

Press the axis going to be changed: , ,

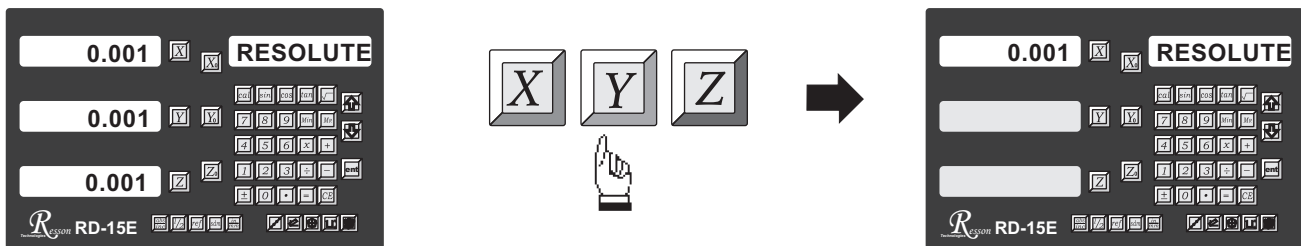

Press or to switch to the correct resolution value from 0.01/0.005/0.002/0.001/0.0005/0.0002/0.0001.

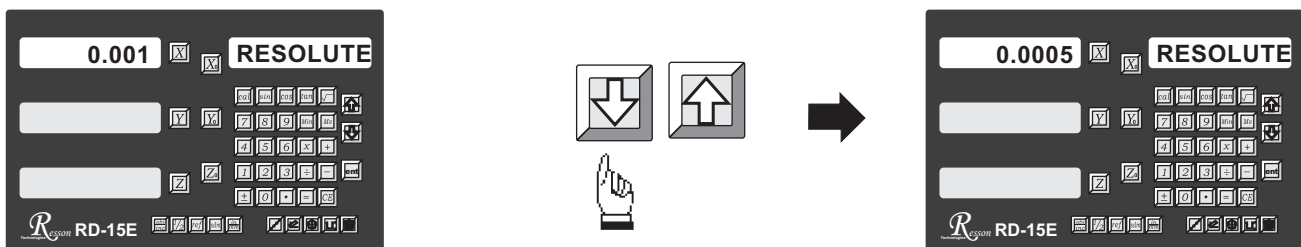



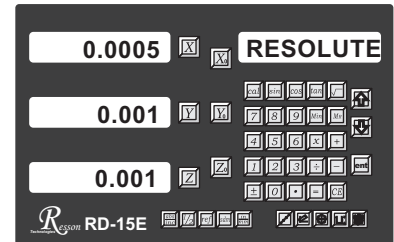
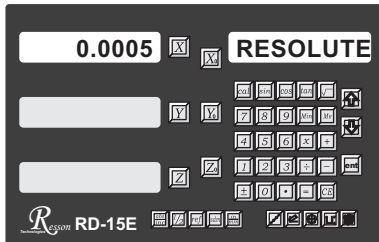

Press  to end up this axis's setup

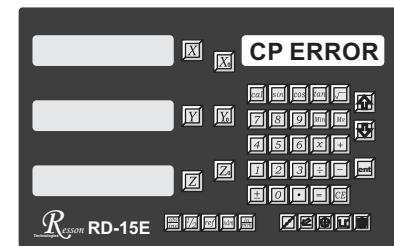
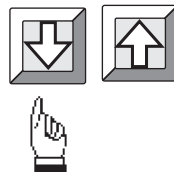
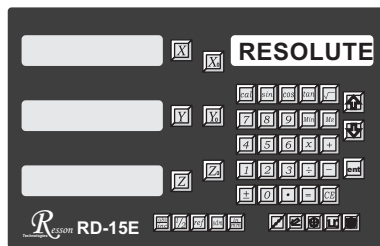

Then, press  to end up the linear scale resolute setup procedure.

7) Press  or  to “CP ERROR” (error compensation).



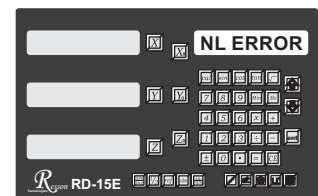
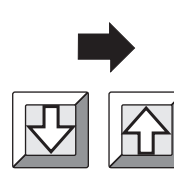
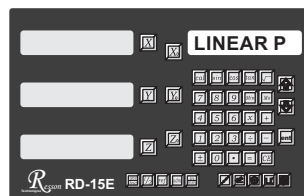
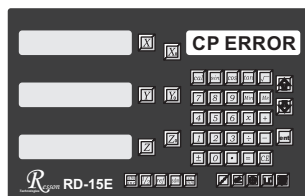

Press  to enter the compensation setup; you can press  or  to switch between the “LINEAR P” (linear compensation) mode and “NL ERROR” (nonlinear compensation) mode; choose one alternatively.



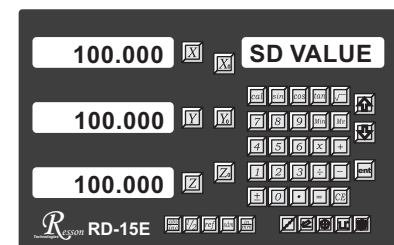
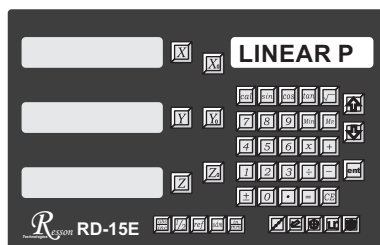

While selecting “LINEAR P”, press  to enter the linear compensation process.



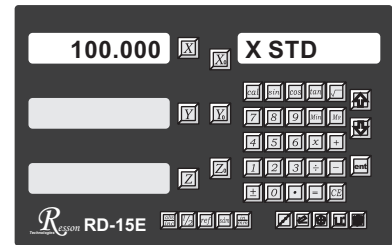
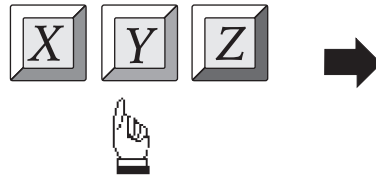
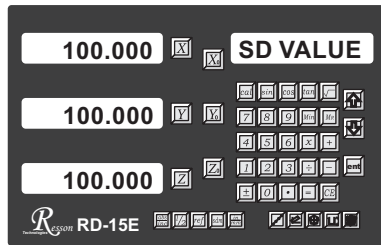

Parameters Setup

Press the axis  ,  or  under compensation.

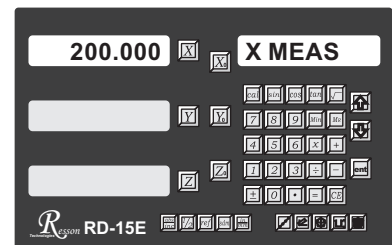
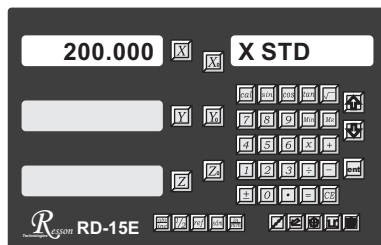

Input the length measured and press  .



Input the actual length and press  .

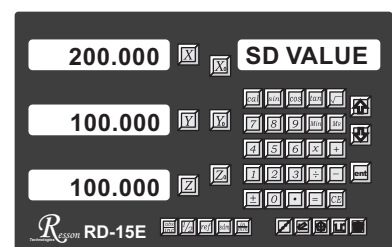
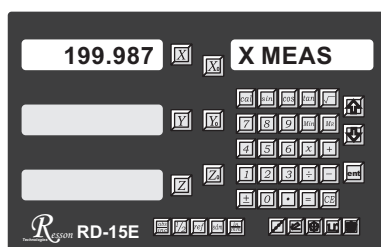



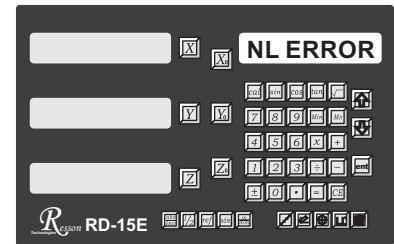
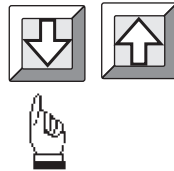
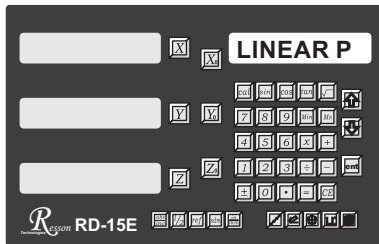

Press other axis  or  under change and follow the above procedure to operate;
after the compensation procedure is done, press  to end up the compensation of linear scale.

Press  or  to switch to “NL ERROR” (nonlinear compensation).

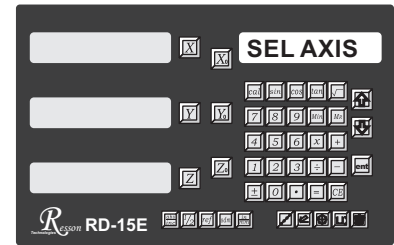
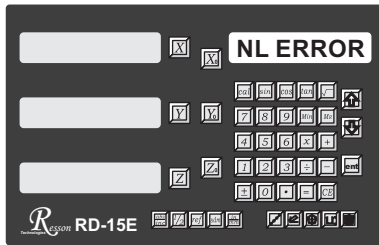

Press  to enter the nonlinear compensation setup.



Press the axis  ,  or  under compensation.

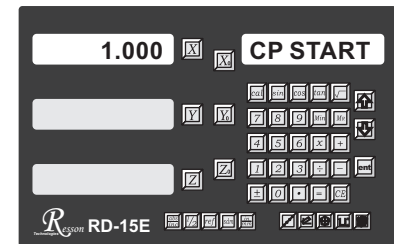
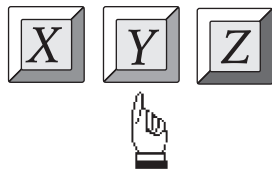
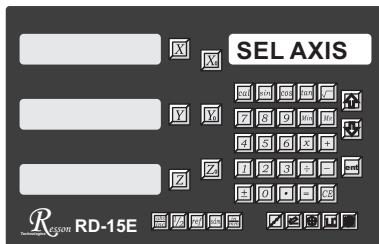

Input CP START

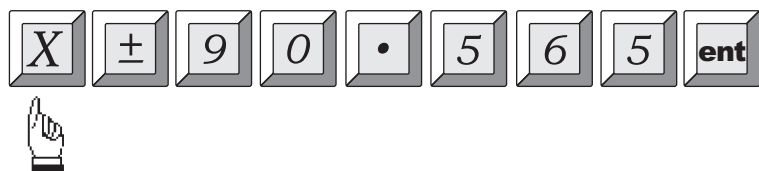
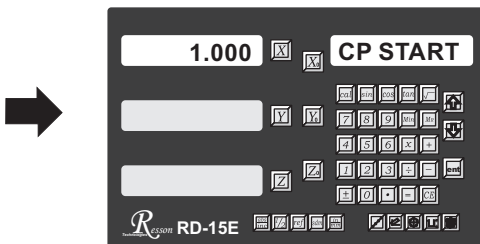

Parameters Setup

Next step

Input CP START

Next step

Input CP STEP



After entering the “Point 1” status, press the up/down key to select the measuring result at the point selected.

Input the measuring result.

----- The measuring result -----

After all data inputs are done, press CE to exit.

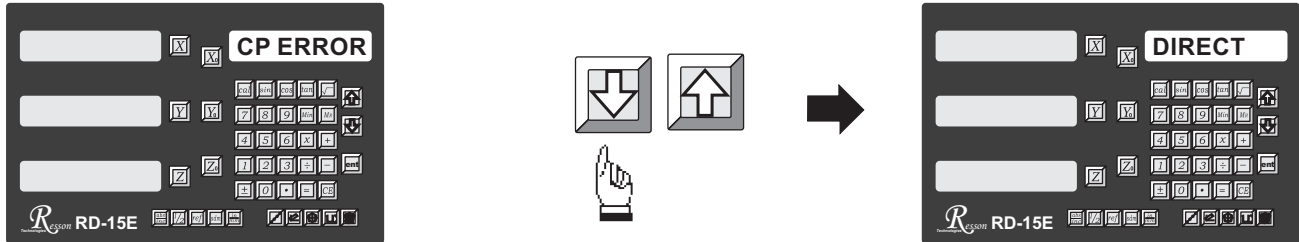

Press up/down key till EXIT appears.

8) Press  or  to move the “DIRECT” (direction setup).

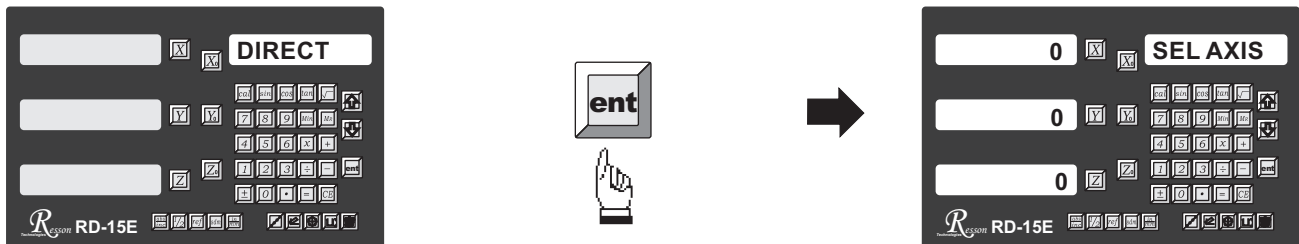

Press  to enter direction setup mode. “0” means in positive direction whereas “1” means the negative direction.



Press  or  to set up X-axis to “1” (negative direction); and do it to Y- & Z-axis similarly.

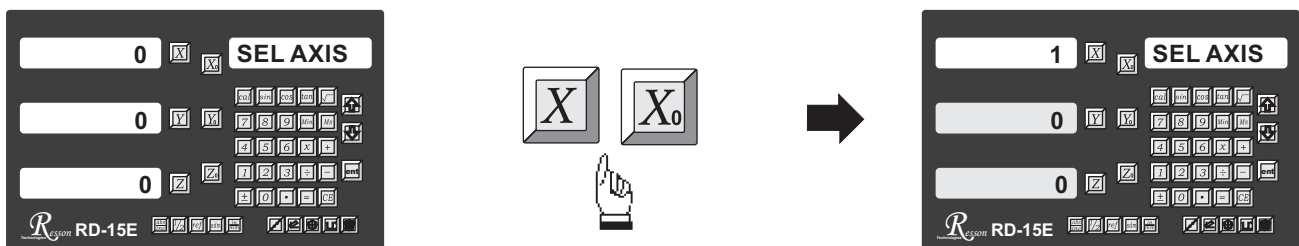

9) Press  to exit; and  or  to “EXIT” and end up the parameter setup.

